

Mod. **PDM**

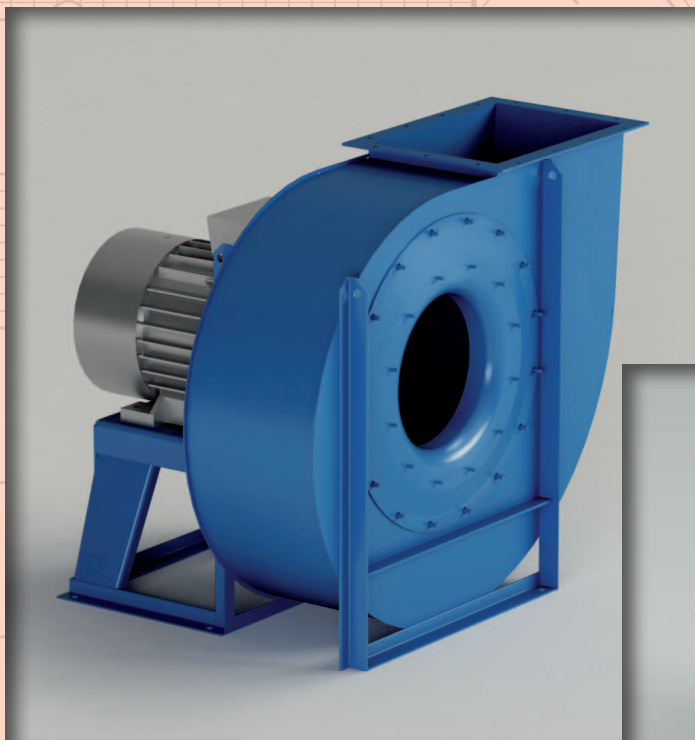

$Q = 200 \div 65000 \text{ m}^3/\text{h}$

$Q = 0.06 \div 18 \text{ m}^3/\text{s}$

$p_t = 300 \div 500 \text{ mmH}_2\text{O}$

$p_t = 3000 \div 5000 \text{ Pa}$

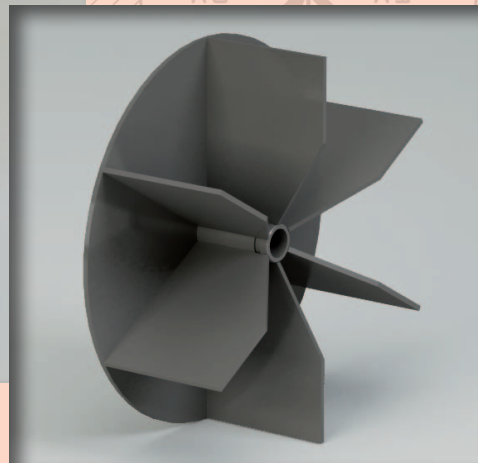

Campo di lavoro

Portate medie. Pressioni medie.

Tipo di pala

Pale radiali dritte, aperta pag. 2.3.

Applicazioni

Per trasporto pneumatico, di materiali solidi in miscela con aria, segatura e trucioli di legno; anche per materiali filamentosi che ostruirebbero una ventola chiusa a pale rovesce.

Esecuzioni costruttive standard

Es.1-Es.4-Es.5-Es.8-Es.9-Es.12, vedi pag. 2.5 - 2.6.

Temperature del fluido standard

-10÷+60°C. Per altre temperature vedi da pag. 1.12 a pag. 1.15.

Tipo di costruzione

Ventilatore in lamiera di Fe360, girante in Fe360 equilibrata staticamente e dinamicamente. Per altri materiali vedi da pag. 1.12 a pag. 1.15.

Dati di funzionamento

Condizioni dell'aria all'aspirazione T=20°C, 0m.s.l.m. e $\rho=1.205 \text{ kg/m}^3$.

Rumorosità

Espressa in potenza sonora L_{wA} [dB(A)] rilevata in campo libero con ventilatore canalizzato, vedi da pag. 1.43 a pag. 1.49.

Orientamenti

N°8 RD (rotazione oraria vista lato trasmissione) e N°8 LG. Ventilatore in versione imbullonata orientabile per le taglie 220-630, con supporto anteriore e quindi non orientabile dalla grandezza 710 a trasmissione, sempre orientabile nei ventilatori direttamente accoppiati senza supporto anteriore. Vedi pag. 2.7.

Costruzioni speciali

Vedi da pag. 2.20 a pag. 2.30.

Avviamento ventilatore

L'avviamento deve avvenire con ventilatore parzializzato, in funzione dell'assorbimento massimo del ventilatore.

Classi giranti

La seguente tabella fa riferimento a condizioni di lavoro standard. In condizioni di esercizio gravose si consiglia di contattare il servizio clienti di CORAL per conoscere la tipologia di girante più idonea. L'avviamento deve avvenire con ventilatore parzializzato, in funzione dell'assorbimento massimo del ventilatore.

■ Domaine de travail

Débits moyens. Moyennes pressions.

Type d'ailette

Ailettes radiales droites, ouverte, voir page 2.3.

Applications

Pour transport pneumatique, de matières solides en mélange dans l'air, de sciure et de copeaux de bois, également pour des matières filamenteuses qui obstrueraient une hélice fermée à ailettes inversées.

Configurations de constructions standard

Ex.1 - Ex.4 - Ex.5 - Ex.8 - Ex.9 - Ex.12, voir pages 2.5 - 2.6.

Températures du fluide standard

-10÷+60°C. Pour d'autres températures voir pages 1.12-1.15.

Type de fabrication

Ventilateur en tôle de Fe360, turbine en Fe360 équilibrée statiquement et dynamiquement. Pour d'autres matériaux, voir pages 1.12-1.15.

Données de fonctionnement

Conditions de l'air à l'aspiration T=20°C, 0 m asl et $\rho=1.205 \text{ kg/m}^3$.

Niveau sonore

Exprimé en puissance sonore L_{wA} [dB(A)], relevé à l'air libre avec un ventilateur canalisé, voir pages 1.43 - 1.49.

Orientations

8 RD (rotation dans le sens des aiguilles d'une montre côté transmission) et 8 LG. Ventilateur en version boulonnée orientable pour les tailles 220-630, avec un support avant et donc non orientable de la grandeur 710 à transmission, toujours orientable dans les ventilateurs directement accouplés sans support avant. Voir page 2.7.

Fabrications spéciales

Voir pages 2.20-2.30.

Mise en marche du ventilateur

Le démarrage doit se faire avec un ventilateur partialisé, en fonction de l'absorption maximale du ventilateur.

Classes de turbines

Le tableau ci-dessus fait référence aux conditions de travail normales, en conditions de travail pénibles, on préconise de contacter le service clientèle de CORAL pour connaître le type de turbine le plus adapté.

GRANDEZZA VENTILATORE • Grandeur • Size • Größe • Tamaño	RPM MASSIMO • Maxi tours/min. • Max rpm • Max. U/min • R.p.m. máx.
	CLASSE I
PDM220	5000
PDM250	5000
PDM280	4750
PDM310	4250
PDM350	4000
PDM400	3500
PDM450	3500
PDM500	3150
PDM560	2940
PDM630	2800
PDM710	2300
PDM800	2000
PDM900	1700
PDM1000	1550
PDM1120	1300
PDM1250	1200

VALORI VALIDI FINO A 60°C

• Valeurs valables jusqu'à 60°C • Values valid up to 60°C
• Werte bis 60°C gültig • Valores válidos hasta 60°C

FRA • entre • between • zwischen • entre	60°C	E • et • and • und • y	100°C	DECLASSARE VELOCITÀ • déclasser vitesse • degrade speed • Geschwindigkeit herabsetzen • rebajar velocidad	4%
	100°C		150°C		200°C
	150°C		200°C		16%
	200°C		250°C		23%
	250°C		300°C		30%
	300°C		350°C		37%
	350°C		400°C		45%
	400°C		450°C		54%
	450°C		500°C		64%

■ Field of operation

Medium rates. Average pressures.

Blade type

Straight radial blades, open, see pg. 2.3.

Applications

For pneumatic transport of solid materials mixed with air, sawdust and wood chips; also suitable for filaments which would block a reversed blade closed fan.

Standard constructional arrangements

Arr.1 - Arr.4 - Arr.5 - Arr.8 - Arr.9 - Arr.12, see pgs. 2.5 - 2.6.

Standard fluid temperatures

-10÷+60°C. For other temperatures see pgs. 1.12 to 1.15.

Type of construction

Fan in Fe360 plate, impeller in Fe360 statically and dynamically balanced. For other materials see pgs. 1.12 to 1.15.

Operating specifications

Condition of inlet air T=20°C, 0 m above sea level and $\rho=1.205 \text{ kg/m}^3$.

Noise level

Expressed as sound power L_{wA} [dB(A)] measured in free field with ducted fan, see pgs. 1.43 to 1.49.

Orientations

No.8 RD (clockwise viewed from transmission side) and No.8 LG. Fan in bolted orientable version for sizes 220-630, with front support and so not orientable for sizes 710 and above with transmission drive, always orientable for directly coupled fans without front support. See pg. 2.7.

Special applications

See pgs. 2.20 to 2.30.

Fan start-up

During start-up the fan flow rate must be limited, calibrated for the fan's maximum electrical input.

Impeller classes

The above table refers to standard operating conditions, in heavy-duty service conditions it is advisable to contact the CORAL Customer Service to establish the most suitable type of impeller.

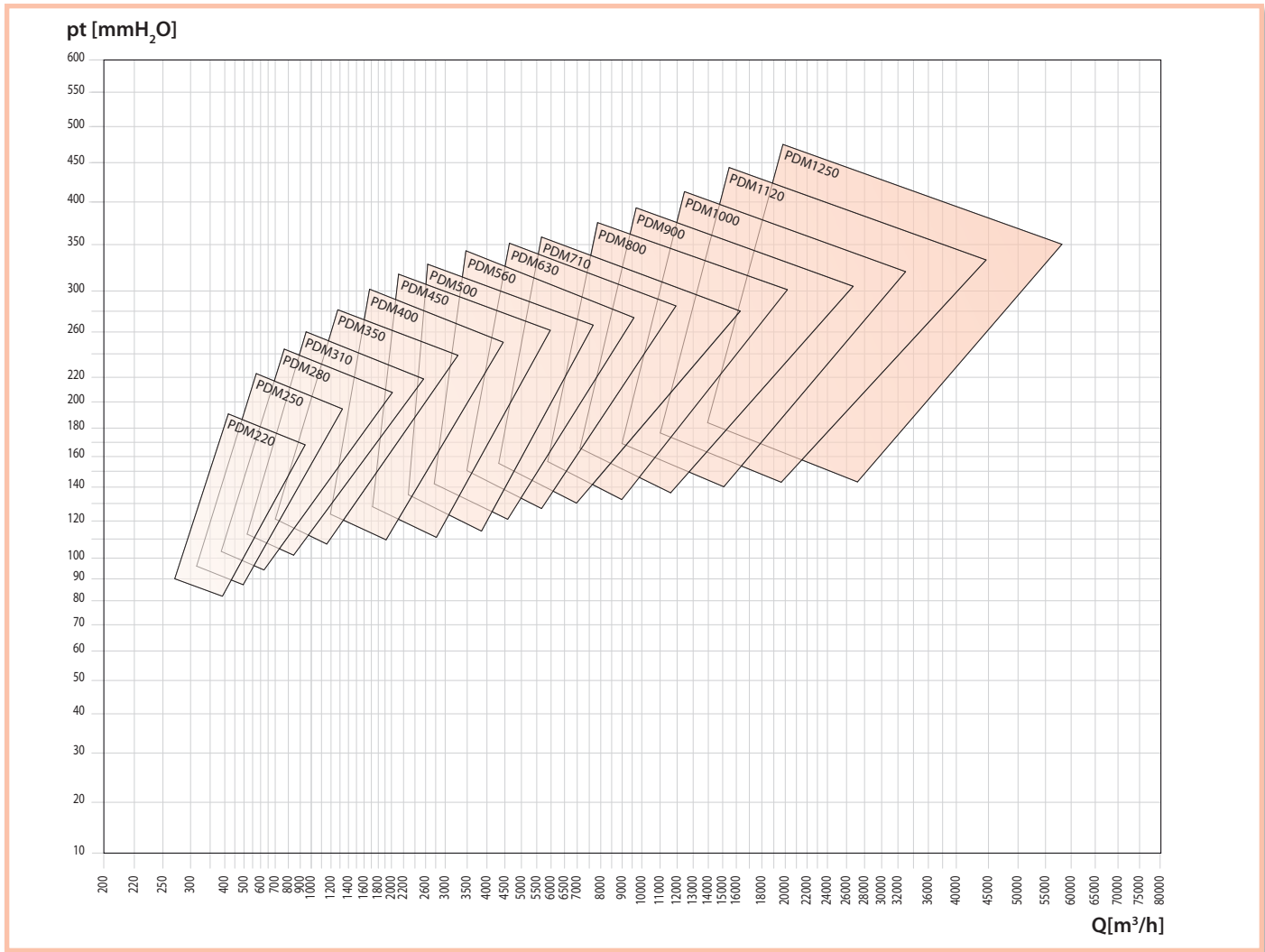

PDM

■ **Arbeitsbereich**

Mittlere Fördermengen. Mittlere Drücke.

Schaufelform

Gerade Radialschaufeln, offen, siehe Seite 2.3.

Anwendungen

Zum Transport von in Luft vermischten Feststoffen, Sägestaub und Holzspäne, auch für fadenförmige Materialien, die einen geschlossenen Ventilator mit rückwärts gekrümmten Schaufeln zusetzen würden.

Konstruktive Standardausführungen

Ausf. 1-Ausf. 4-Ausf. 5-Ausf. 8-Ausf. 9-Ausf. 12, siehe Seiten 2.5 - 2.6.

Standardtemperatur des Mediums

-10 ÷ +60°C. Für andere Temperaturen siehe Seiten 1.12 bis 1.15.

Konstruktionsart

Ventilator aus Blech Fe360, Laufrad aus Fe360, statisch und dynamisch ausgewuchtet. Für andere Materialien siehe Seiten 1.12 bis 1.15.

Betriebsdaten

Physikalischer Zustand der Ansaugluft T = 20°C, 0 m ü. M. und ρ = 1.205 kg/m³.

Geräuschpegel

Angegeben als Schalleistungspegel L_{wA} [dB(A)] mit Messung im Freifeld und an Rohren angeschlossenem Ventilatore, siehe Seiten 1.43 bis 1.49.

Ausrichtung

8 Modelle RD (Drehrichtung im Uhrzeigersinn, von Antriebsseite aus gesehen) und 8 Modelle LG. Angeschraubter, in der Ausrichtung veränderbarer Ventilator in den Größen 220 - 630, mit Vorderstütze und damit nicht veränderbar ab Größe 710 mit Riementrieb, immer ausrichtbar bei allen direkt angetriebenen Ventilatoren ohne Vorderstütze, siehe Seite 2.7.

Spezialausführungen

Siehe Seiten 2.20 bis 2.30.

Ventilator-Anlauf

Der Ventilatoranlauf muss bei teilweise geschlossenem Ventilator erfolgen, in Abhängigkeit von der maximalen Stromaufnahme des Motors.

Laufradklassen

Die obenstehende Tabelle bezieht sich auf normale Betriebsbedingungen. Bei erschwerenden Betriebsbedingungen wird empfohlen, den Kundenservice von CORAL zu kontaktieren, um den am besten geeigneten Laufradtyp zu bestimmen.

■ **Campo de trabajo**

Caudales medios. Presiones medias.

Tipo de pala

Palas radiales rectas, abierta, ver pág. 2.3.

Aplicaciones

Para transporte neumático de materiales sólidos mezclados con aire, serrín y virutas de madera; también para materiales filamentosos que obstruirían un ventilador cerrado de palas invertidas.

Variantes constructivas estándares

Ejec.1-Ejec.4-Ejec.5-Ejec.8-Ejec.9-Ejec.12, ver págs. 2.5 - 2.6.

Temperaturas del fluido estándares

De -10 a +60°C. Para otras temperaturas, ver págs. de 1.12 a 1.15.

Tipo de construcción

Ventilador de chapa en Fe360, rotor en Fe360 equilibrado estática y dinámicamente. Para otros materiales, ver págs. de 1.12 a 1.15.

Datos de funcionamiento

Condiciones del aire en aspiración T=20°C, 0 m SNM y ρ=1.205 kg/m³.

Niveles de ruido

Expresados en potencia sonora L_{wA} [dB(A)] medida en campo abierto en ventilador canalizado, ver págs. de 1.43 a 1.49.

Orientaciones

8 RD (rotación dextrógira vista desde el lado de transmisión) y 8 LG. Ventilador en versión empernada orientable para tamaños 220-630, con soporte delantero, por lo cual no es orientable a partir del tamaño 710 de transmisión, siempre orientable en ventiladores acoplados directamente sin soporte delantero. Ver pág. 2.7.

Construcciones especiales

Ver págs. de 2.20 a 2.30.

Puesta en marcha del ventilador

La puesta en marcha debe efectuarse con ventilador parcializado, en función de la absorción máxima del ventilador.

Clases de rotores

La tabla arriba hace referencia a condiciones de trabajo estándares, en condiciones de funcionamiento pesadas se aconseja llamar al Servicio de atención al cliente de CORAL para conocer el tipo de rotor más adecuado.

Tipo • Type • Type • Typ • Tipo	Motore • Moteur • Fan • Ventilator • Ventilador	P inst. [kW]	n	LpA [dB(A)]	Tolleranza sulla portata $\pm 5\%$ • Tolérance sur le débit $\pm 5\%$ • Load tolerance $\pm 5\%$ • Durchsatztoleranz $\pm 5\%$ • Tolerancia respecto caudal $\pm 5\%$																		
					Q [m ³ /h]																		
					325	360	400	430	470	540	650	720	790	865	935	1080	1225	1370	1440	1620	1800	2160	
					pt[mmH ₂ O]																		
PDM220/2	71	0,37	2740	60	71	71	70	69	68	65	57	51	48	42									
PDM250/2R	71	0,55	2800	62		90	90	89	89	88	85	80	76	72	68	56							
PDM250/2	80	0,75	2855	63				101	101	100	98	96	93	90	84	73	66						
PDM280/2R	80	1,1	2855	64					109	108	107	106	105	102	99	88	80	71					
PDM280/2	90	1,5	2855	66						126	125	125	124	124	122	117	112	100	97	86	75		
PDM310/2R	90	1,5	2855	66							130	128	126	125	124	116	110	102	98	86			
PDM310/2	90	2,2	2880	68										163	160	158	156	155	152	146	140	128	122
PDM350/2R	100	3	2900	70													183	179	177	176	175	163	152
PDM350/2	112	4	2905	72															205	204	201	199	184
PDM400/2R	132	5,5	2925	74																		244	240
PDM400/2	132	7,5	2930	76																			271
PDM450/2R	132	9,2	2940	77																			
PDM450/2	160	11	2940	80																			
PDM500/2R	160	15	2940	80																			
PDM500/2	180	22	2960	82																			
PDM450/4	90	1,5	1440	65															83	82	81	78	
PDM500/4R	100	2,2	1440	66																		90	88
PDM500/4	100	3	1440	67																			102
PDM560/4R	112	4	1440	69																			
PDM560/4	132	5,5	1460	70																			
PDM630/4R	132	7,5	1460	72																			
PDM630/4	160	11	1460	73																			
PDM710/4R	160	11	1460	76																			
PDM710/4	160	15	1460	76																			
PDM800/4R	180	18,5	1460	79																			
PDM800/4	200	30	1470	80																			
PDM900/4R	225	37	1470	82																			
PDM900/4	225	45	1470	82																			
PDM1000/4R	250	55	1480	84																			
PDM1000/4	280	75	1480	85																			

Il livello di pressione sonora ponderato A, LpA (cap.14), corrisponde al valore rilevato, nelle condizioni di prova, nel punto di massima rumorosità.

Tolleranza sulla rumorosità ±4dB(A)																										
• Tolérance sur le bruit ±4dB(A) • Noise tolerance ±4dB(A)																										
• Geräushtoleranz ±4dB(A) • Tolerancia respecto a ruido ±4dB(A)																										
Q [m³/h]																										
2520	2880	3240	3600	3960	4320	4680	5400	6120	7200	7920	9000	10080	10800	12600	14400	16200	18000	19800	21600	25200	28800	32400	36000	42120		
pt[mmH ₂ O]																										
137																										
170	162	142	120																							
236	230	220	195	178	165																					
269	265	245	235	224	214	208	159																			
311	310	308	306	299	285	275	245	220																		
	344	342	340	338	333	323	300	285	230																	
	387	384	380	375	368	363	352	345	316	298	283															
		438	436	434	433	431	428	416	400	385	365	340	320													
76	69	61	51																							
85	82	80	76	73	68	62																				
99	97	95	93	90	86	81	74																			
	119	117	115	114	110	107	102	94																		
	132	130	129	128	126	124	118	112	102																	
			146	145	144	142	137	133	124	117																
				168	167	166	164	160	153	147	139	129														
							190	185	181	176	170	162	157	143												
								211	210	207	202	196	190	177												
										251	247	243	239	231	219	209	197	180								
											270	268	266	264	260	251	241	230	219	204						
													324	321	314	306	300	290	281	260	234					
														345	341	334	328	321	312	296	271					
																398	393	386	381	365	350	331	309			
																	430	428	425	421	412	398	381	360	341	

PDM

■ Le niveau de pression sonore pondérée A, LpA (chap. 14), correspond à la valeur relevée dans les conditions d'essai au point de niveau sonore maximum.

■ Der nach A bewertete Schalldruckpegel LpA (Kap. 14) entspricht in den Testbedingungen dem höchsten gemessenen Wert des Geräuschpegels.

■ The A-weighted sound power level, LpA (Chap.14), is the value measured in test conditions at the point of maximum noise level.

■ El nivel de presión sonora ponderado A, LpA (cap. 14), corresponde al valor medido, en las condiciones de prueba, en el punto con máximos niveles de ruido.

Tolleranza sulla rumorosità ±4dB(A)
 • Tolérance sur le bruit ±4dB(A) • Noise tolerance ±4dB(A)
 • Geräushtoleranz ±4dB(A) • Tolerancia respecto a ruido ±4dB(A)

Q [m³/h]																								
2520	2880	3240	3600	3960	4320	4680	5400	6120	7200	7920	9000	10080	10800	12600	14400	16200	18000	19800	21600	25200	28800	32400	36000	42120
pt[mmH ₂ O]																								
138																								
170	164	145	125																					
233	228	219	196	180	168																			
264	261	243	234	225	216	211	166																	
303	303	301	300	294	281	272	245	223																
	335	333	332	331	327	318	298	285	236															
	374	372	368	364	358	354	344	339	313	298	286													
		422	420	419	418	417	415	405	392	380	363	342	325											
77	70	63	53																					
85	82	81	77	74	70	64																		
99	97	95	94	91	87	83	77																	
	118	116	115	114	110	107	103	96																
	131	129	128	128	126	124	119	113	105															
			145	144	143	141	136	133	125	118														
				166	165	164	163	159	153	148	141	132												
							188	183	180	175	170	163	158	146										
								208	208	205	201	196	190	179										
										246	243	240	236	229	219	210	200	185						
										265	263	262	260	257	250	241	232	223	210					
												316	313	308	301	296	287	280	262	240				
													336	333	327	322	317	309	296	275				
															385	381	375	371	358	345	329	310		
															415	414	412	408	402	390	376	359	344	

PDM

■ Le niveau de pression sonore pondérée A, LpA (chap. 14), correspond à la valeur relevée dans les conditions d'essai au point de niveau sonore maximum.

■ Der nach A bewertete Schalldruckpegel LpA (Kap. 14) entspricht in den Testbedingungen dem höchsten gemessenen Wert des Geräuschpegels.

■ The A-weighted sound power level, LpA (Chap.14), is the value measured in test conditions at the point of maximum noise level.

■ El nivel de presión sonora ponderado A, LpA (cap. 14), corresponde al valor medido, en las condiciones de prueba, en el punto con máximos niveles de ruido.

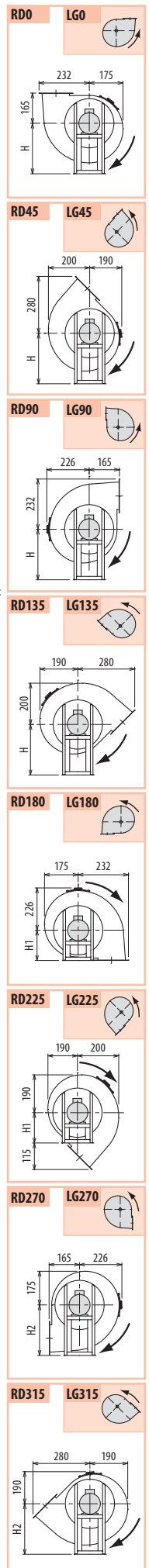
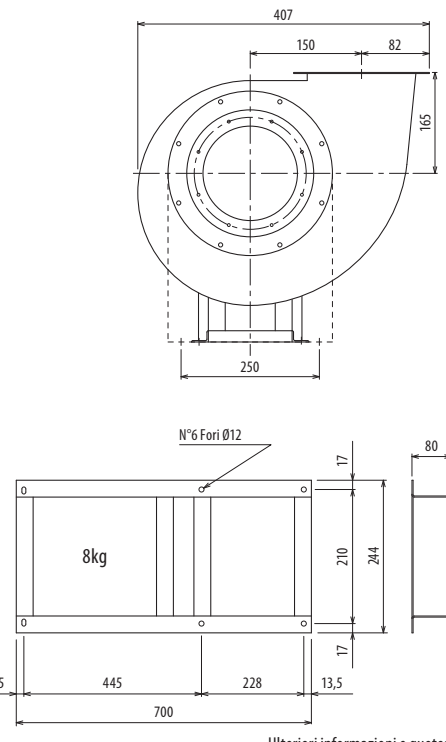
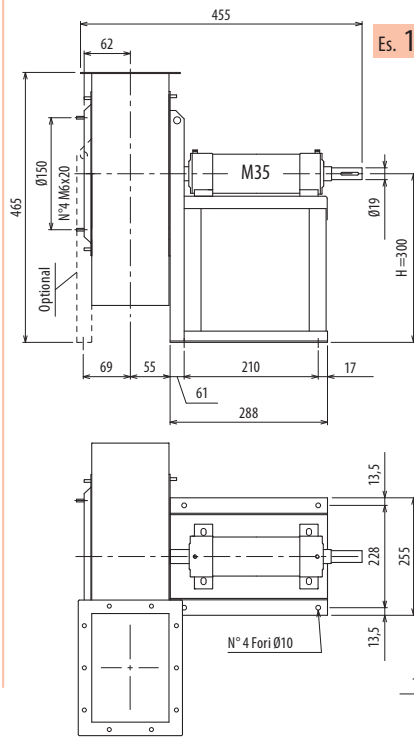
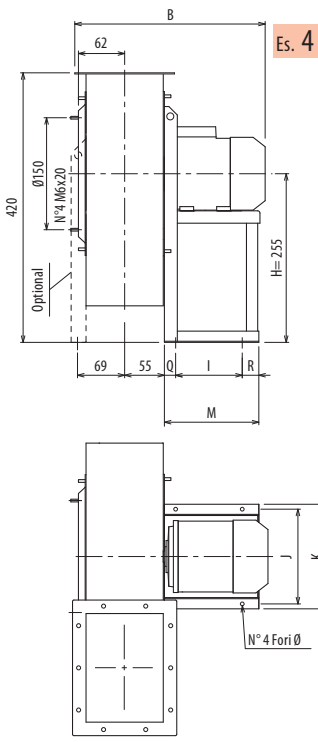

Il ventilatore è orientabile - Peso in tabella comprensivo di motore

- Le ventilateur est orientable
- The fan is revolvable
- Der Ventilator ist drehbar
- El ventilador es orientable
- Further information and sizes:
- Weitere Infos und Größen:
- Más informaciones y medidas:

TIPO - Type		PESO Weight	PD ²	B	I	H	H1	H2	J	K	M	Q	R	Ø
VENTILATORE Fan	MOTORE Motor	Kg	Kgf x m ²											
PDM220/2	71 A2	20	0,08	337	121	255	165	255	203	225	195	48	26	10
PDM220/T		20	0,08			300	180	300						

Ulteriori informazioni e quote:
■ Ulérieures informations et cotes:
■ Further information and sizes:
■ Weitere Infos und Größen:
■ Más informaciones y medidas:

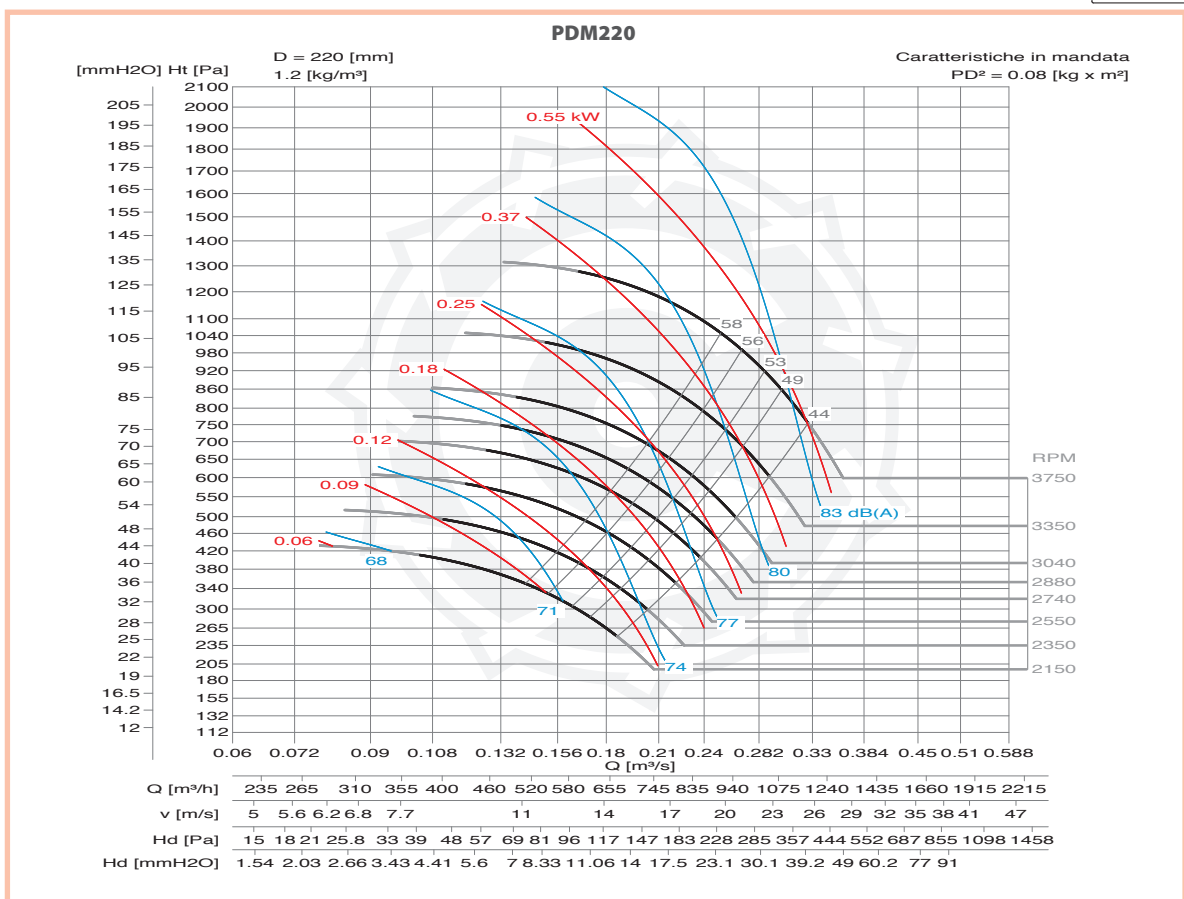
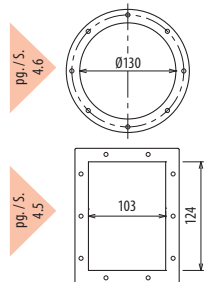

DIMENSIONI D'INGOMBRO E PESI/CURVE DI FUNZIONAMENTO

■ DIMENSIONS D'ENCOMBREMENT ET POIDS/COURBES DE FONCTIONNEMENT ■ OVERALL DIMENSIONS AND WEIGHT/WORKING CURVES
 ■ AUSMAßE UND GEWICHTE/FUNKTIONSKURVEN ■ DIMENSIONES QUE OCUPA Y PESOS/CURVAS DE FUNCIONAMIENTO

PDM250

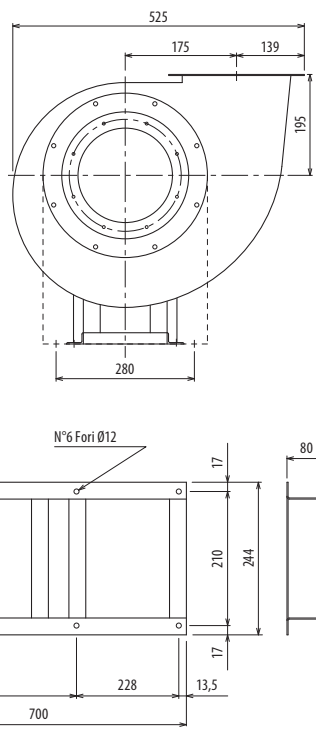
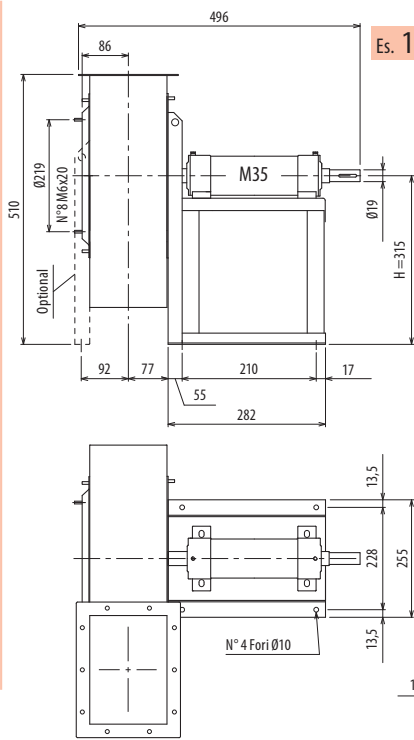
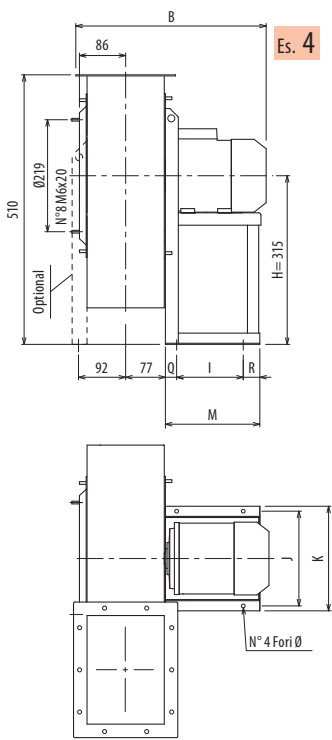

Il ventilatore è orientabile - Peso in tabella comprensivo di motore

- Le ventilateur est orientable
 - The fan is revolvable
 - Der Ventilator ist drehbar
 - El ventilador es orientable
- Le poids dans le tableau inclut le moteur The weight indicated in the table includes motor Gewichtsangabe in Tabelle inkl. Motor El peso en la tabla incluye el motor

Ulteriori informazioni e quote:
 ■ Ulérieures informations et cotes:
 ■ Further information and sizes:
 ■ Weitere Infos und Größen:
 ■ Más informaciones y medidas:

TIPO - Type		PESO Weight	PD ² Kg x m ²	B	I	H	H1	H2	J	K	M	Q	R	Ø
VENTILATORE Fan	MOTORE Motor													
PDM250/2R	71 B2	25	0,09	396	121	315	195	315	203	225	195	48	26	10
PDM250/2	80 A2	30	0,10	420	121	315	195	315	203	225	217	48	48	10
PDM250/T		25	0,10			315	195	315						

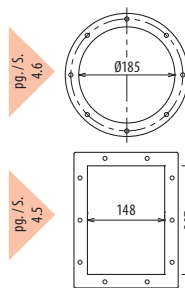

RD0 LG0

RD45 LG45

RD90 LG90

RD135 LG135

RD180 LG180

RD225 LG225

RD270 LG270

RD315 LG315

PDM

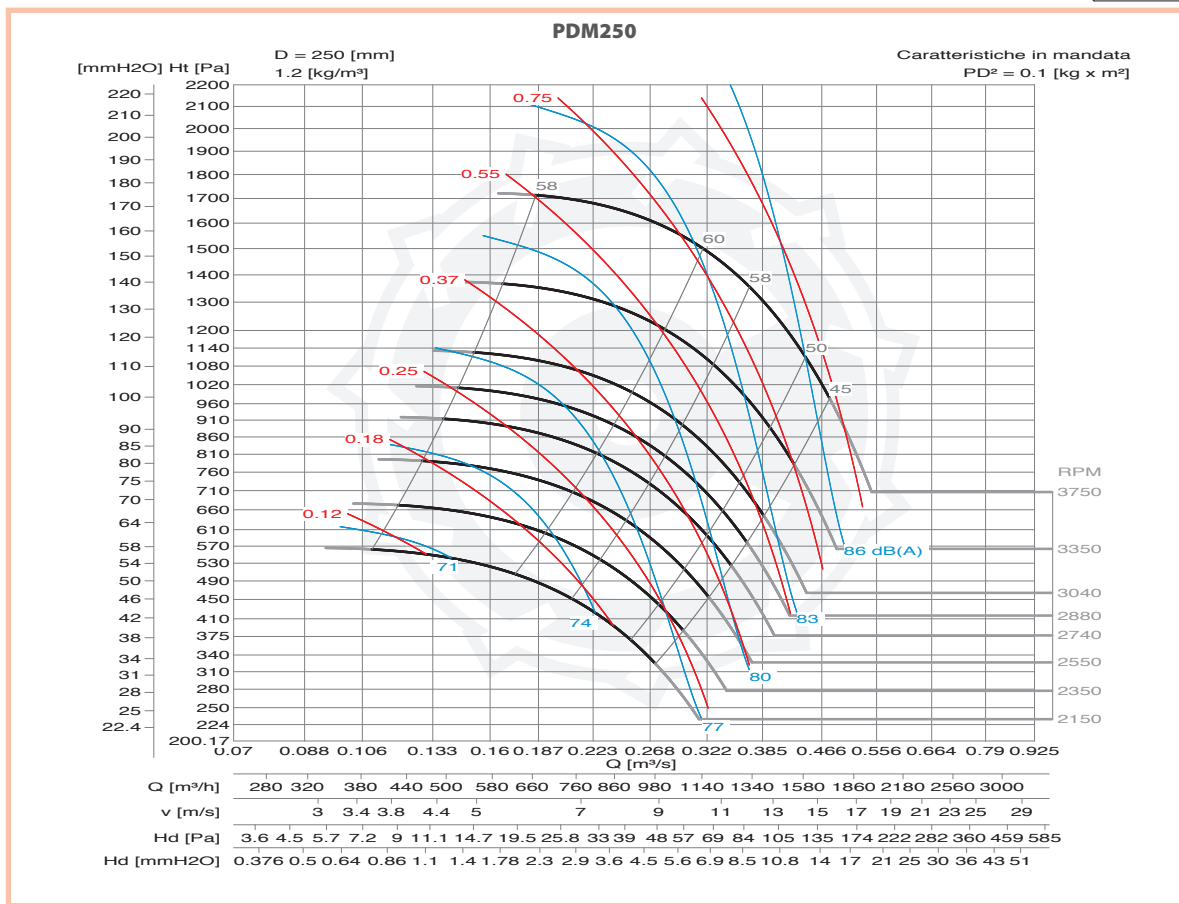

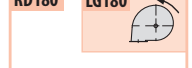
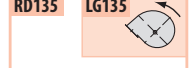
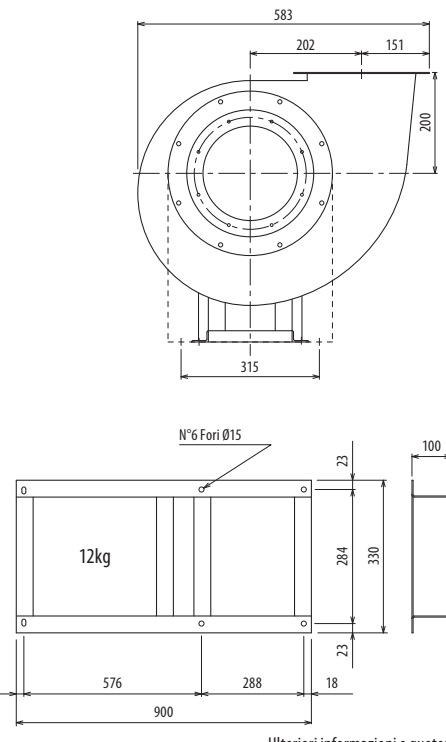
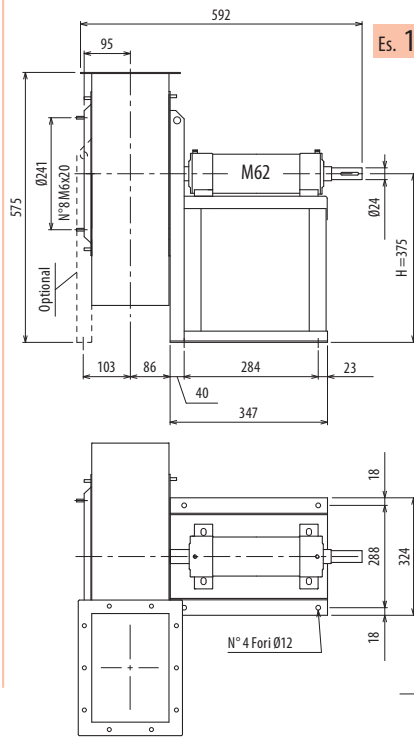
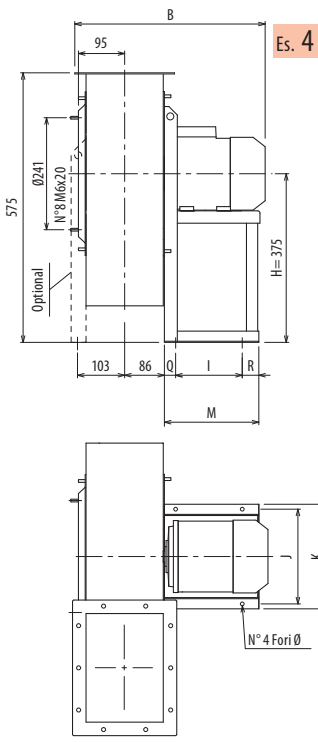

Il ventilatore è orientabile - Peso in tabella comprensivo di motore

- Le ventilateur est orientable
- The fan is revolvable
- Der Ventilator ist drehbar
- El ventilador es orientable
- Further information and sizes:
- Weitere Infos und Größen:
- Más informaciones y medidas:

TIPO - Type		PESO Weight	PD ²	B	I	H	H1	H2	J	K	M	Q	R	Ø
VENTILATORE Fan	MOTORE Motor													
PDM280/2R	80 B2	33	0,15	438	121	375	200	375	203	225	217	48	48	10
PDM280/2	90 S2	37	0,16	485	133	375	200	375	234	260	251	58	60	10
PDM280/T		40	0,16			375	200	375						

Ulteriori informazioni e quote:
■ Ulérieures informations et cotes:
■ Further information and sizes:
■ Weitere Infos und Größen:
■ Más informaciones y medidas:

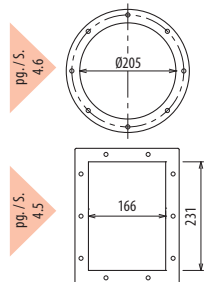

PDM

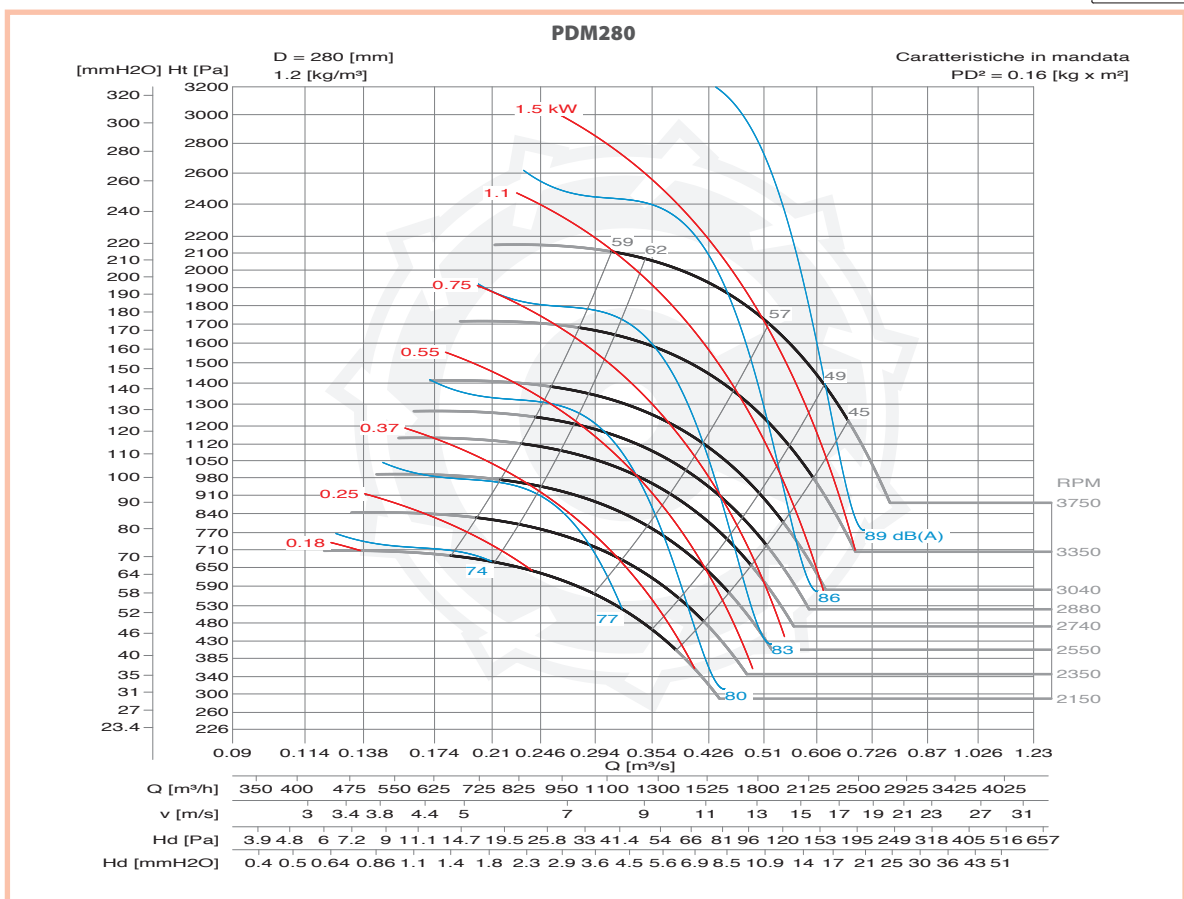

DIMENSIONI D'INGOMBRO E PESI/CURVE DI FUNZIONAMENTO

■ DIMENSIONS D'ENCOMBREMENT ET POIDS/COURBES DE FONCTIONNEMENT ■ OVERALL DIMENSIONS AND WEIGHT/WORKING CURVES
 ■ AUSMAßE UND GEWICHTE/FUNKTIONSKURVEN ■ DIMENSIONES QUE OCUPA Y PESOS/CURVAS DE FUNCIONAMIENTO

PDM310

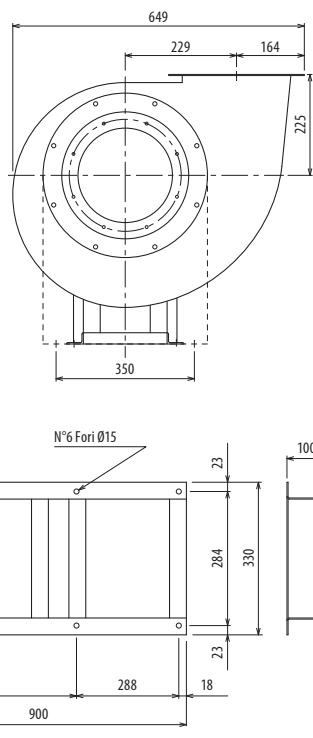
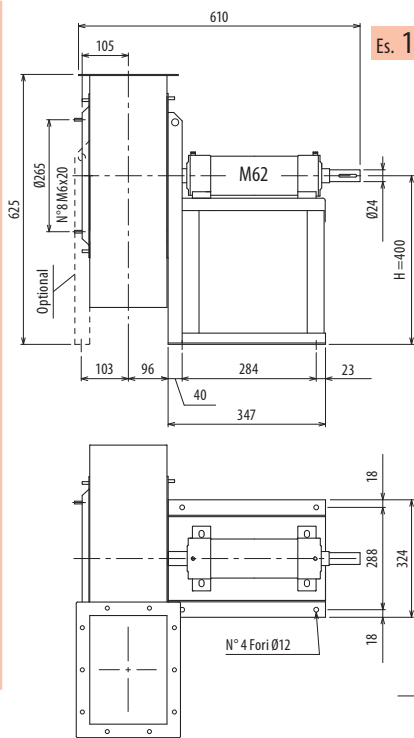
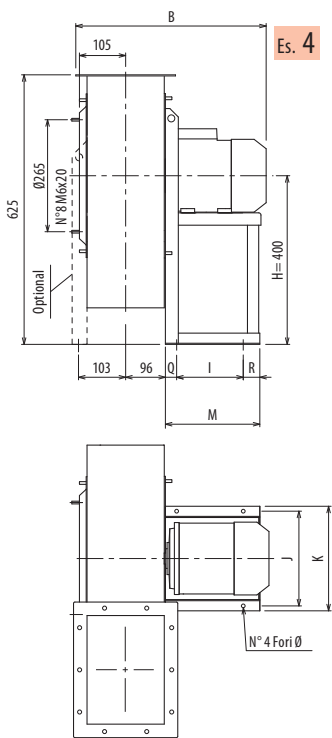

Il ventilatore è orientabile - Peso in tabella comprensivo di motore

■ Le ventilateur est orientable ■ The fan is revolvable ■ Der Ventilator ist drehbar ■ El ventilador es orientable
 Le poids dans le tableau inclut le moteur The weight indicated in the table includes motor Gewichtsangabe in Tabelle inkl. Motor El peso en la tabla incluye el motor

Ulteriori informazioni e quote:

■ Ulérieures informations et cotes: ■ Further information and sizes: ■ Weitere Infos und Größen: ■ Más informaciones y medidas:

TIPO - Type		PESO Weight	PD ²	B	I	H	H1	H2	J	K	M	Q	R	Ø
VENTILATORE Fan	MOTORE Motor													
PDM310/2R	90 S2	43	0,19	505	133	400	225	400	234	260	246	55	58	10
PDM310/2	90 L2	47	0,21	505	133	400	225	400	234	260	246	55	58	10
PDM310/T		45	0,21			400	225	400						

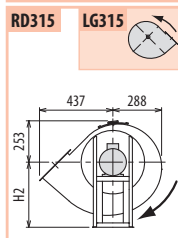
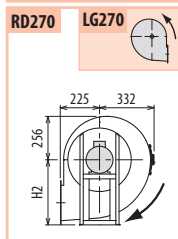
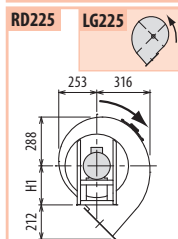
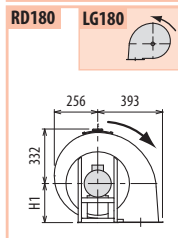
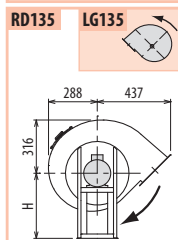
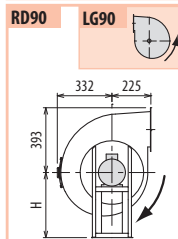
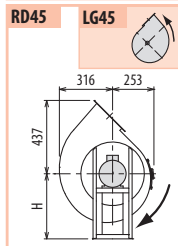
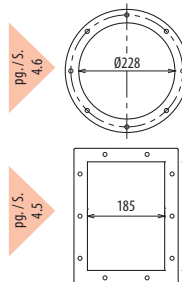

PDM

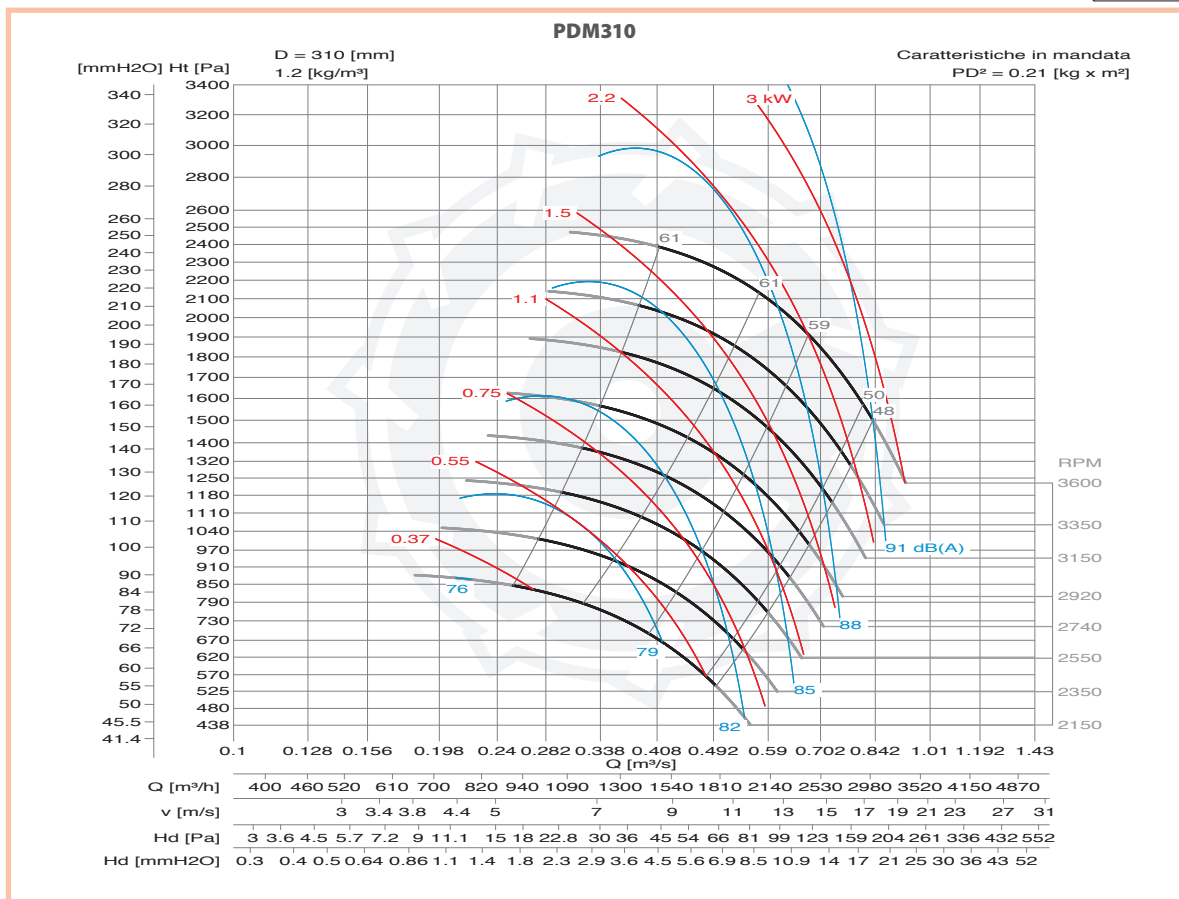

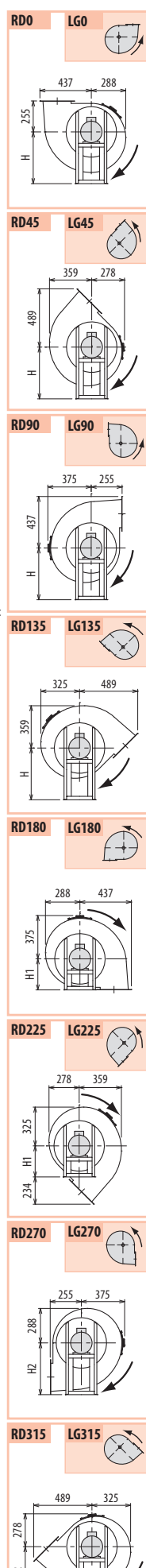
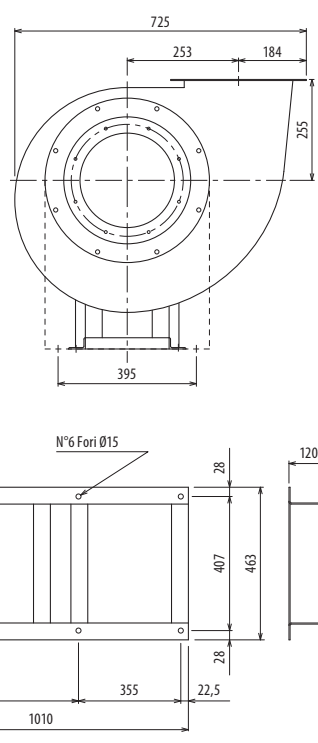
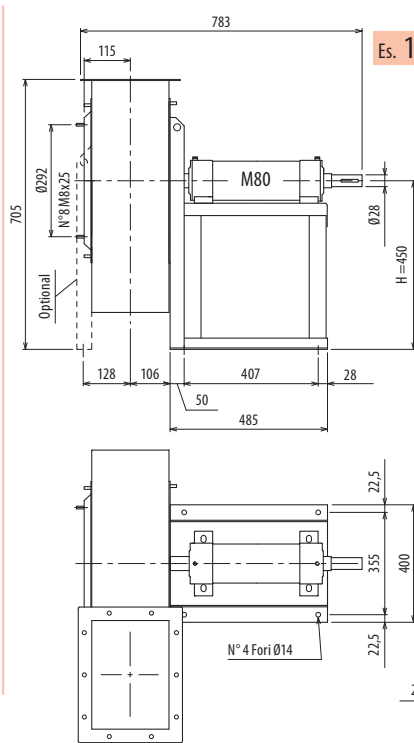
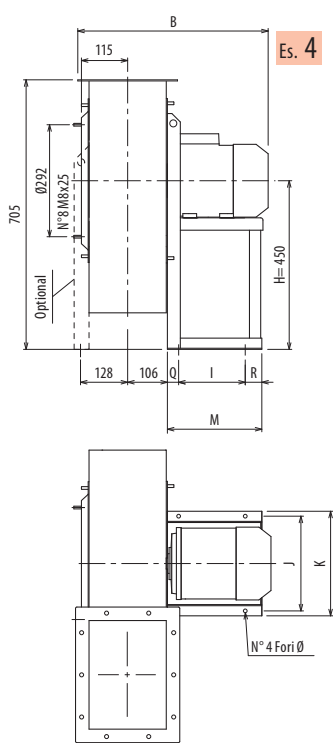

Il ventilatore è orientabile - Peso in tabella comprensivo di motore

- Le ventilateur est orientable
 - The fan is revolvable
 - Der Ventilator ist drehbar
 - El ventilador es orientable
- Le poids dans le tableau inclut le moteur
 ■ The weight indicated in the table includes motor
 ■ Gewichtsangabe in Tabelle inkl. Motor
 ■ El peso en la tabla incluye el motor

Ulteriori informazioni e quote:

- Ulérieures informations et cotes:
- Further information and sizes:
- Weitere Infos und Größen:
- Más informaciones y medidas:

TIPO - Type		PESO Weight	PD ²											
VENTILATORE Fan	MOTORE Motor	Kg	Kgf x m ²	B	I	H	H1	H2	J	K	M	Q	R	Ø
PDM350/2R	100 LA2	63	0,44	561	197	450	255	450	289	324	276	30	49	12
PDM350/2	112 M2	72	0,50	582	197	450	255	450	289	324	276	30	49	12
PDM350/T		75	0,50			450	255	450						

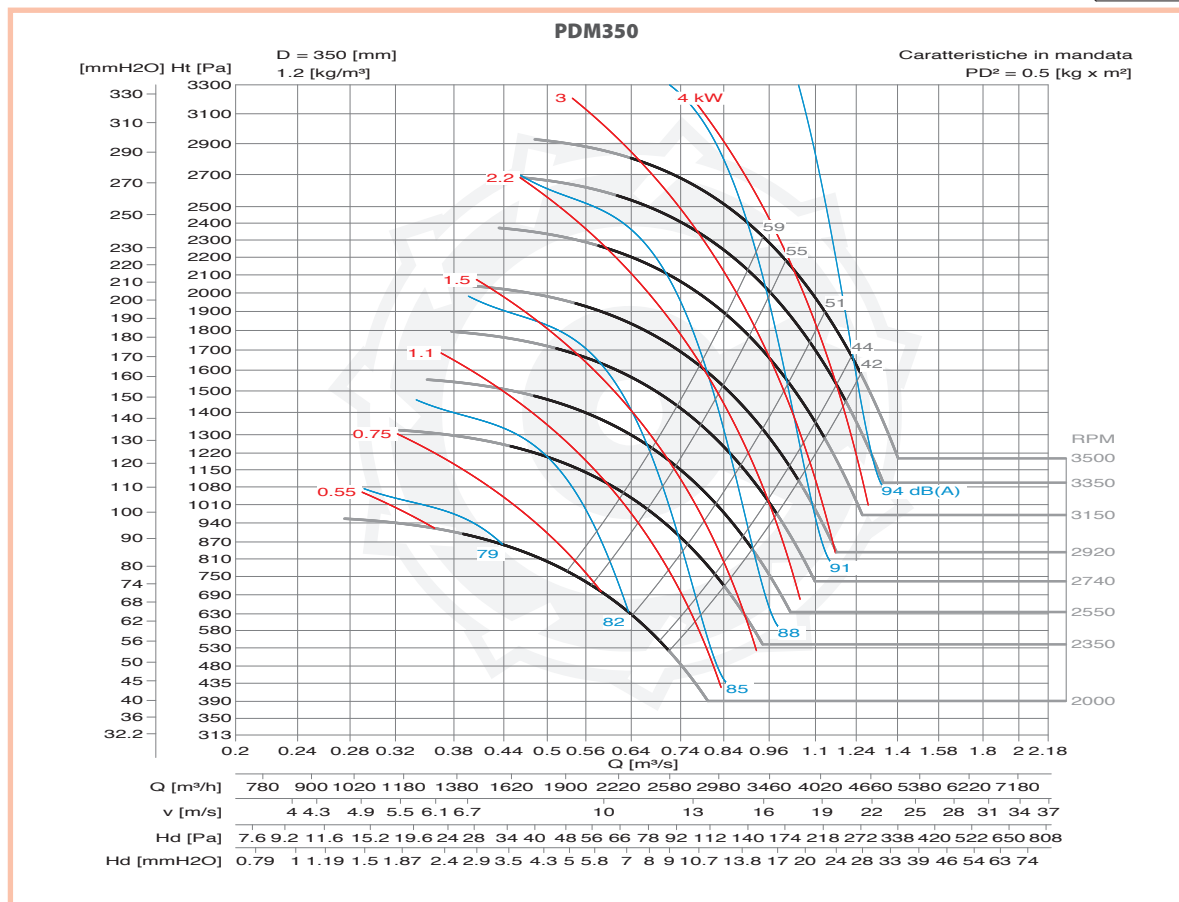
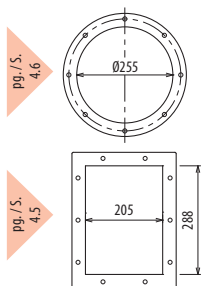

DIMENSIONI D'INGOMBRO E PESI/CURVE DI FUNZIONAMENTO

■ DIMENSIONS D'ENCOMBREMENT ET POIDS/COURBES DE FONCTIONNEMENT ■ OVERALL DIMENSIONS AND WEIGHT/WORKING CURVES
 ■ AUSMAßE UND GEWICHTE/FUNKTIONSKURVEN ■ DIMENSIONES QUE OCUPA Y PESOS/CURVAS DE FUNCIONAMIENTO

PDM400

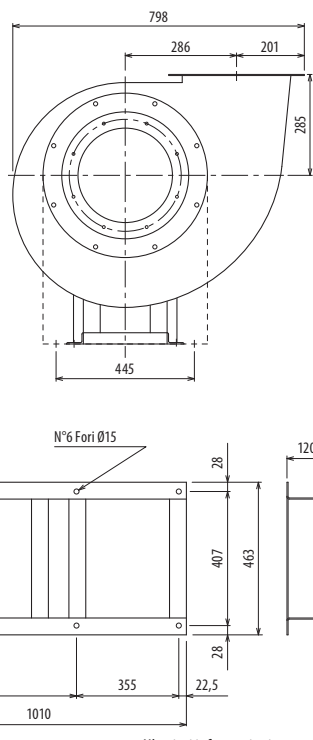
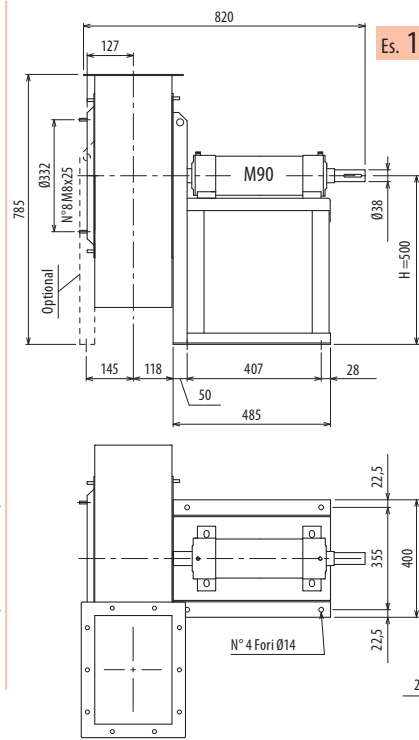
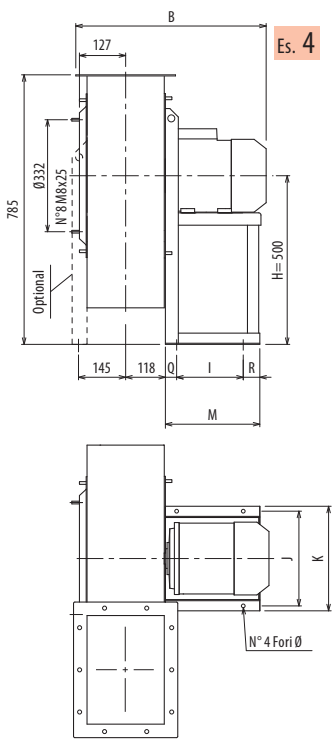

Il ventilatore è orientabile - Peso in tabella comprensivo di motore

- Le ventilateur est orientable
 - The fan is revolvable
 - Der Ventilator ist drehbar
 - El ventilador es orientable
- Le poids dans le tableau inclut le moteur The weight indicated in the table includes motor Gewichtsangabe in Tabelle inkl. Motor El peso en la tabla incluye el motor

Ulteriori informazioni e quote:

- Ulérieures informations et cotes:
- Further information and sizes:
- Weitere Infos und Größen:
- Más informaciones y medidas:

TIPO - Type		PESO Weight	PD ²	B	I	H	H1	H2	J	K	M	Q	R	Ø
VENTILATORE Fan	MOTORE Motor	Kg	Kg x m ²											
PDM400/2R	132 SA2	101	0,72	646	237	500	285	500	337	372	336	40	59	12
PDM400/2	132 SB2	106	0,85	646	237	500	285	500	337	372	336	40	59	12
PDM400/T		86	0,85			500	285	500						

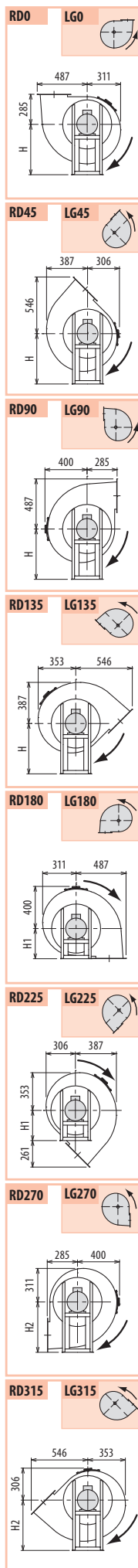
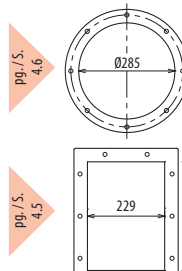

PDM

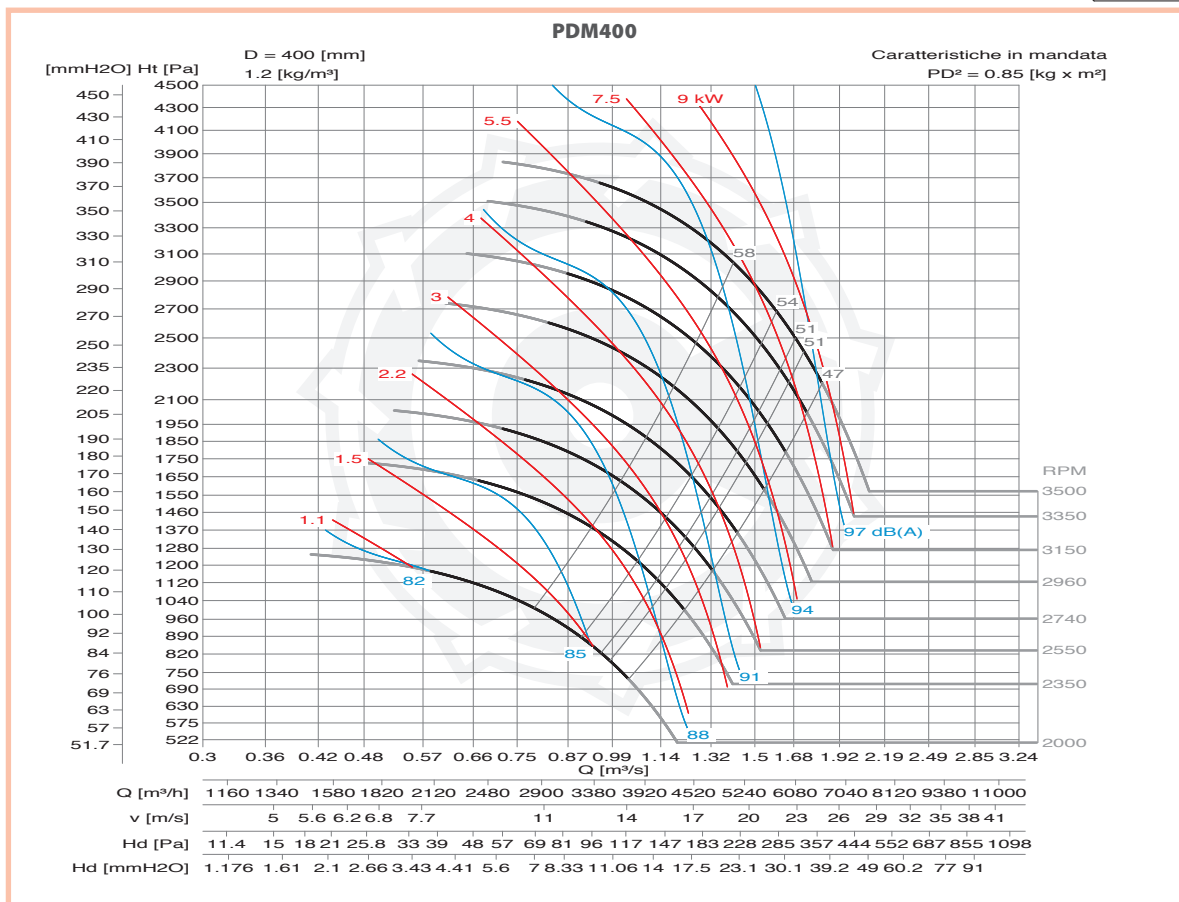

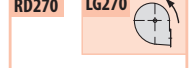
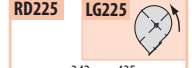
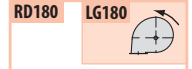
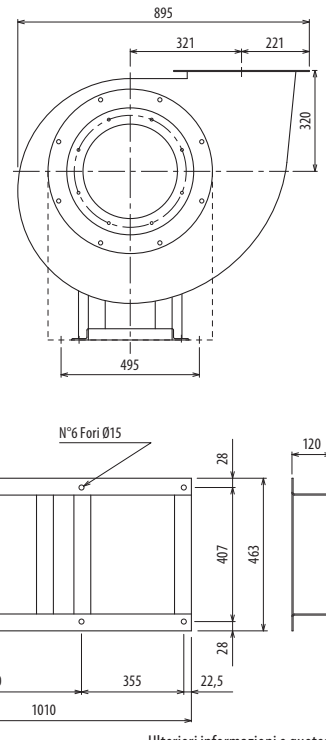
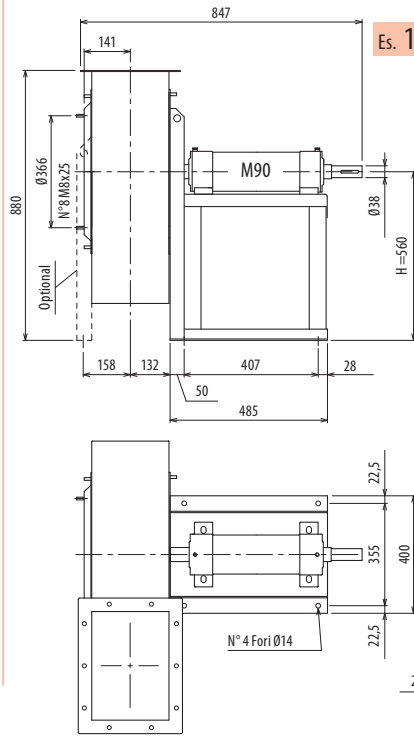
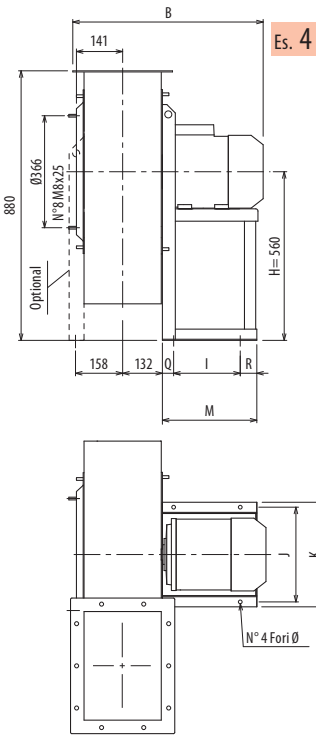

Il ventilatore è orientabile - Peso in tabella comprensivo di motore

- Le ventilateur est orientable
- The fan is revolvable
- Der Ventilator ist drehbar
- El ventilador es orientable
- Further information and sizes:
- Weitere Infos und Größen:
- Más informaciones y medidas:

TIPO - Type		PESO Weight	PD ²	B	I	H	H1	H2	J	K	M	Q	R	Ø
VENTILATORE Fan	MOTORE Motor	Kg	Kgf x m ²											
PDM450/2R	132 MB2	121	1,4	673	237	560	320	560	337	372	336	40	59	12
PDM450/2	160 MA2	155	1,6	778	337	560	320	560	395	440	436	50	49	14
PDM450/4	90 L4	85	1,6	581	133	560	320	560	234	260	246	55	58	10
PDM450/T		98	1,60			560	320	560						

Ulteriori informazioni e quote:
■ Ulérieures informations et cotes:
■ Further information and sizes:
■ Weitere Infos und Größen:
■ Más informaciones y medidas:

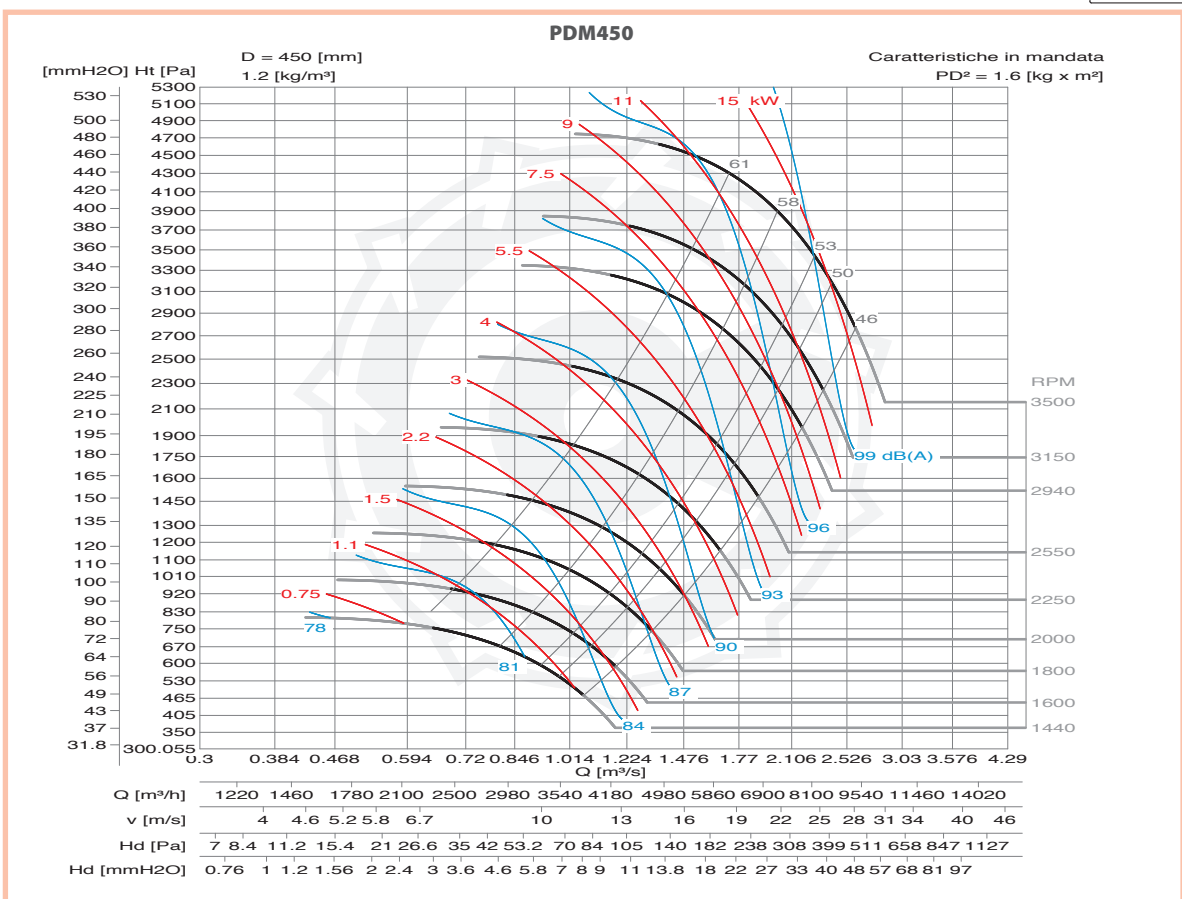
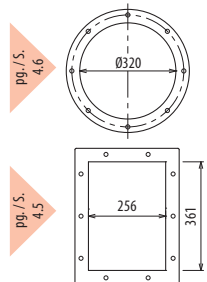

DIMENSIONI D'INGOMBRO E PESI/CURVE DI FUNZIONAMENTO

■ DIMENSIONS D'ENCOMBREMENT ET POIDS/COURBES DE FONCTIONNEMENT ■ OVERALL DIMENSIONS AND WEIGHT/WORKING CURVES
 ■ AUSMAßE UND GEWICHTE/FUNKTIONSKURVEN ■ DIMENSIONES QUE OCUPA Y PESOS/CURVAS DE FUNCIONAMIENTO

PDM500



ANTIPOLLUTION SYSTEMS

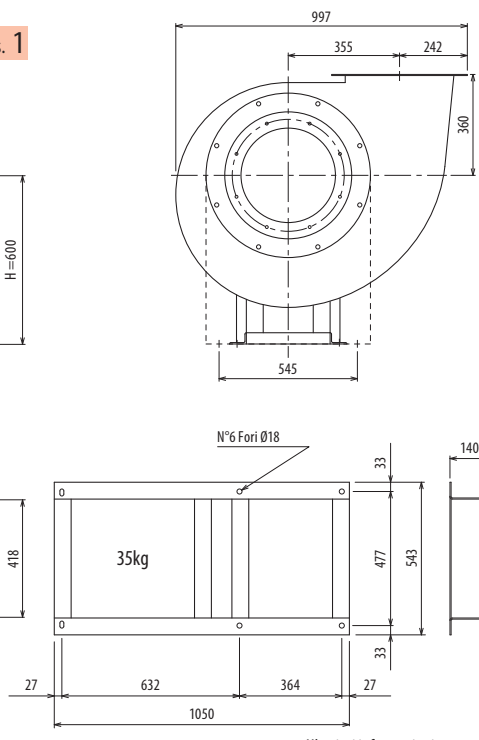
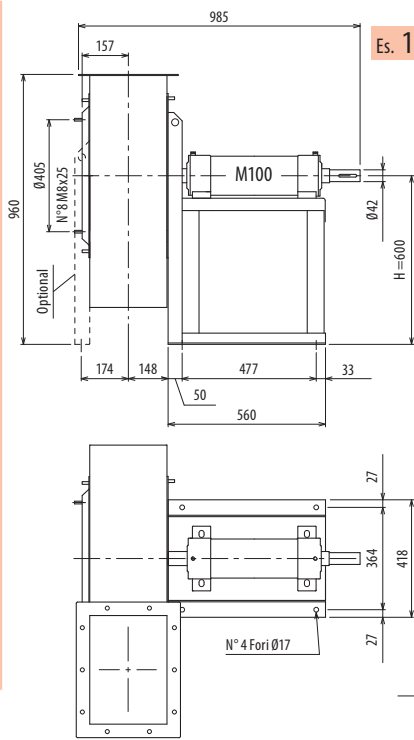
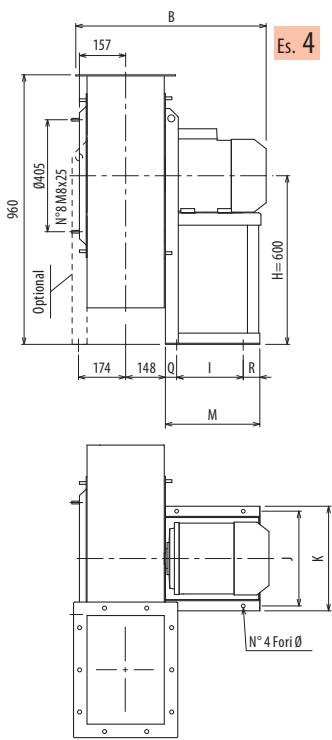

Il ventilatore è orientabile - Peso in tabella comprensivo di motore

- Le ventilateur est orientable
 - The fan is revolvable
 - Der Ventilator ist drehbar
 - El ventilador es orientable
- Le poids dans le tableau inclut le moteur The weight indicated in the table includes motor Gewichtsangabe in Tabelle inkl. Motor El peso en la tabla incluye el motor

Ulteriori informazioni e quote:
 ■ Ulérieures informations et cotes:
 ■ Further information and sizes:
 ■ Weitere Infos und Größen:
 ■ Más informaciones y medidas:

TIPO - Type		PESO Weight	PD ²	B	I	H	H1	H2	J	K	M	Q	R	Ø
VENTILATORE Fan	MOTORE Motor	Kg	Kgf x m ²											
PDM500/2R	160 MB2	180	2,3	810	337	600	360	600	395	440	436	50	49	14
PDM500/2	180 M2	250	2,6	891	357	600	360	600	434	488	460	70	33	17
PDM500/4R	100 LA4	112	2,4	644	197	600	360	600	289	324	276	30	49	12
PDM500/4	100 LB4	117	2,7	644	197	600	360	600	289	324	276	30	49	12
PDM500/T		115	2,60			600	360	600						

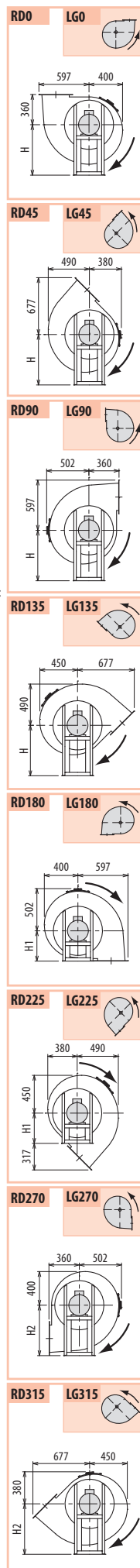
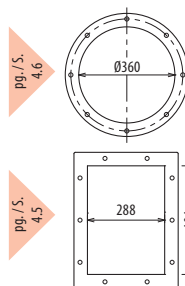

PDM

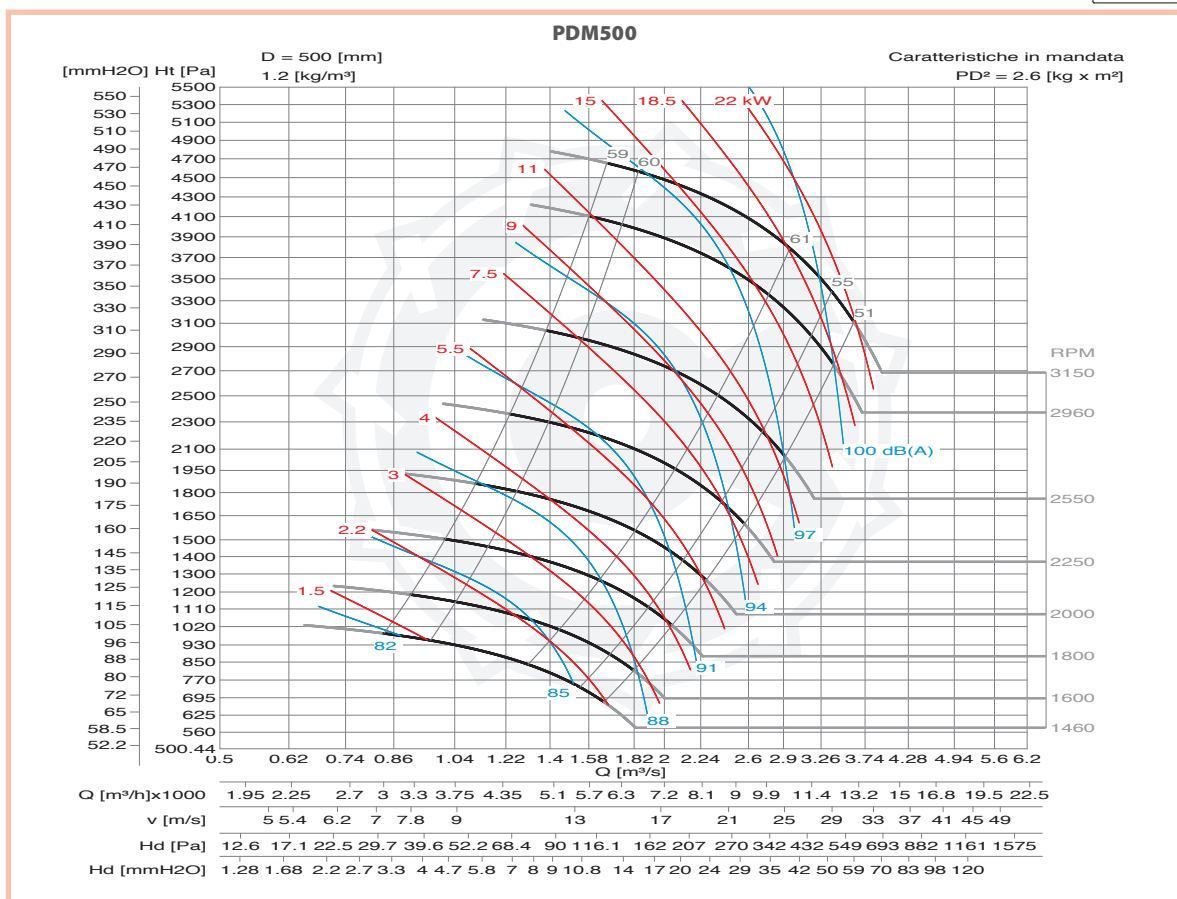

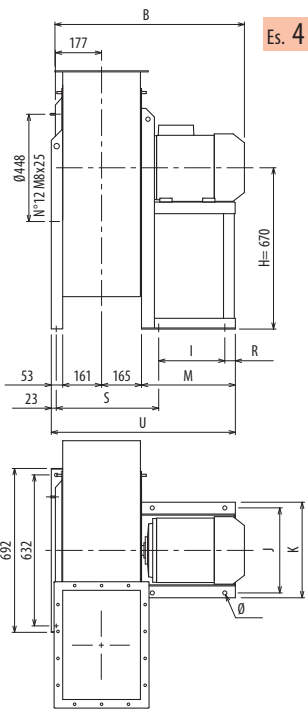

Es. 4

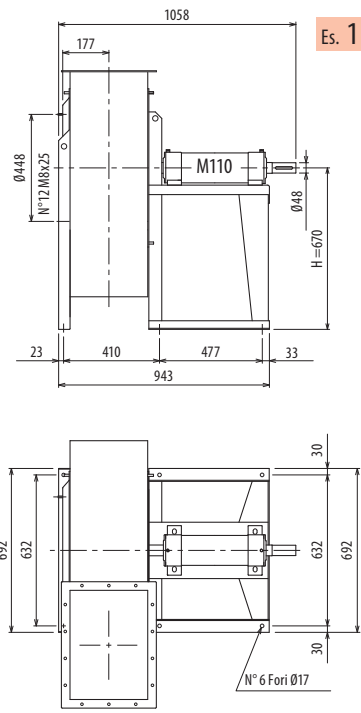

Es. 1

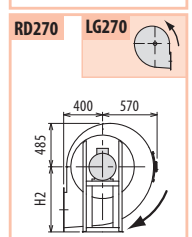
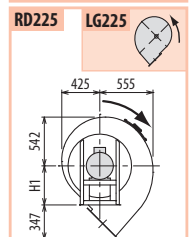
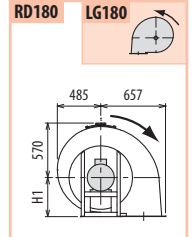
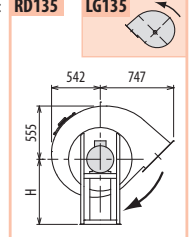
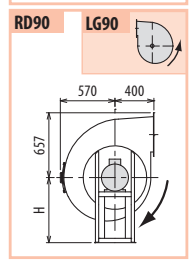
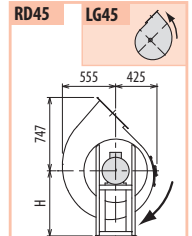
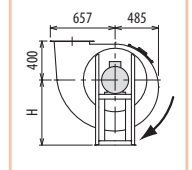
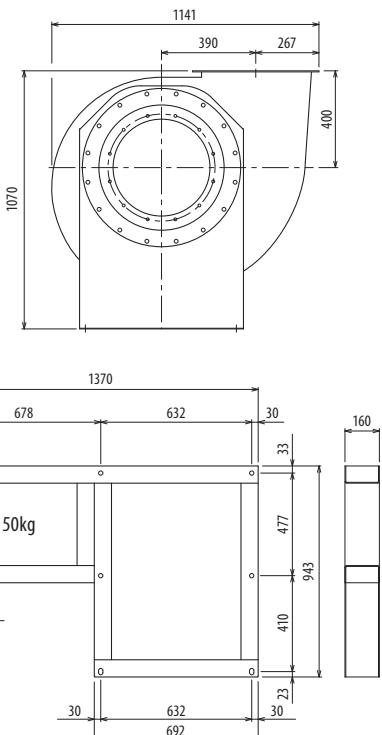

Il ventilatore è orientabile - Peso in tabella comprensivo di motore

- Le ventilateur est orientable
- The fan is revolvable
- Der Ventilator ist drehbar
- El ventilador es orientable
- Ulteriori informazioni e quote:
- Further information and sizes:
- Weitere Infos und Größen:
- Más informaciones y medidas:

TIPO - Type		PESO Weight	PD ²												
VENTILATORE Fan	MOTORE Motor	Kg	Kgf x m ²	B	I	H	H1	H2	J	K	M	R	S	U	Ø
PDM560/4R	112 M4	156	4	712	197	670	400	670	289	324	277	49	387	656	12
PDM560/4	132 S4	177	4,8	752	237	670	400	670	337	372	337	59	397	716	12
PDM560/T		200	4,8			670	400	670							

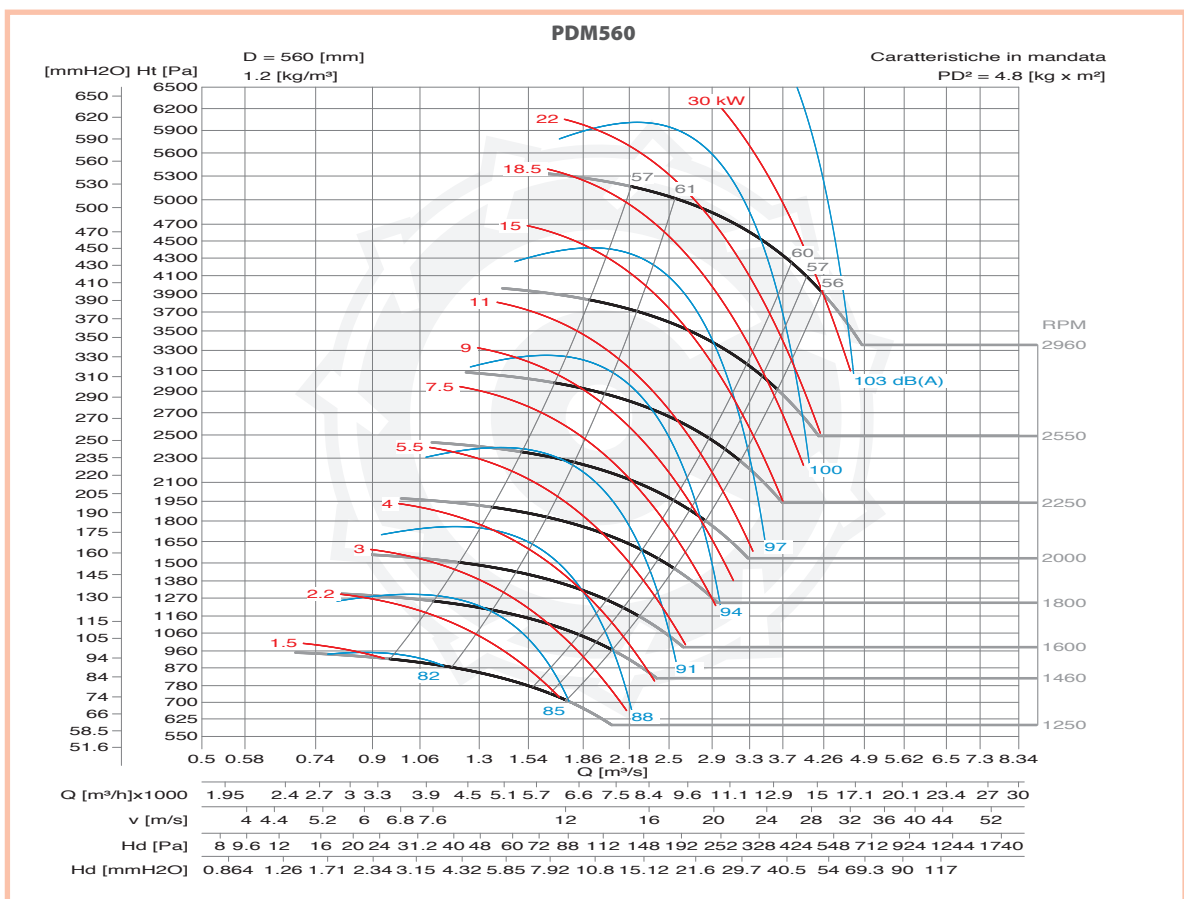
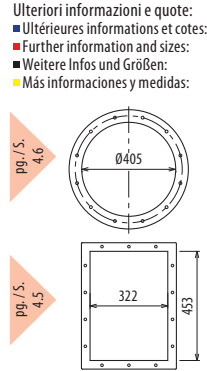

DIMENSIONI D'INGOMBRO E PESI/CURVE DI FUNZIONAMENTO

■ DIMENSIONS D'ENCOMBREMENT ET POIDS/COURBES DE FONCTIONNEMENT ■ OVERALL DIMENSIONS AND WEIGHT/WORKING CURVES
 ■ AUSMAßE UND GEWICHTE/FUNKTIONSKURVEN ■ DIMENSIONES QUE OCUPA Y PESOS/CURVAS DE FUNCIONAMIENTO

PDM630

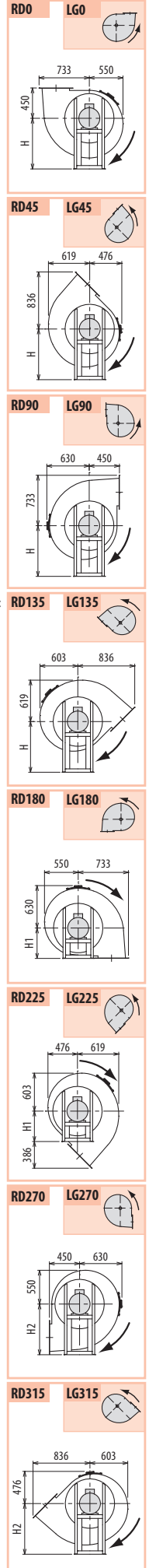
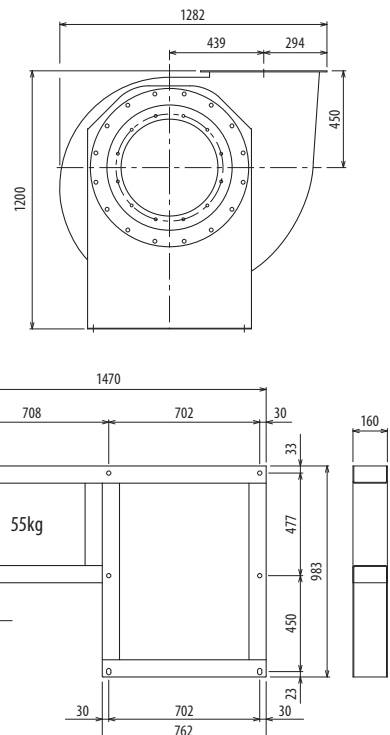
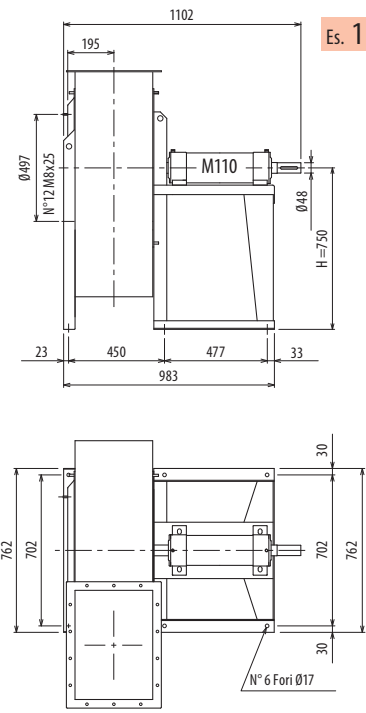
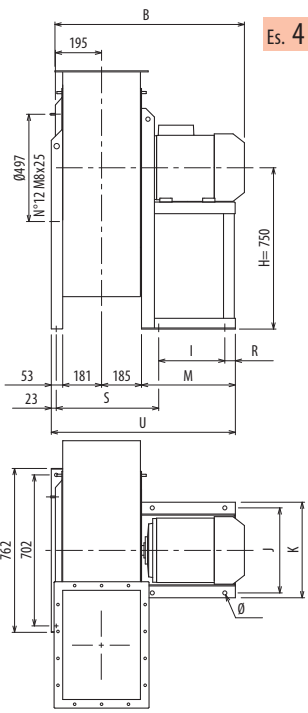

Il ventilatore è orientabile - Peso in tabella comprensivo di motore

- Le ventilateur est orientable
- The fan is revolvable
- Der Ventilator ist drehbar inkl. Motor
- El ventilador es orientable
- The weight indicated in the table includes motor
- Gewichtsangabe in Tabelle inkl. Motor
- El peso en la tabla incluye el motor

TIPO - Type		PESO Weight	PD ²	B	I	H	H1	H2	J	K	M	R	S	U	Ø
VENTILATORE Fan	MOTORE Motor	Kg	Kgf x m ²												
PDM630/4R	132 M4	202	5,8	792	237	750	450	750	337	372	337	59	436	755	12
PDM630/4	160 M4	250	6,5	897	337	750	450	750	395	440	437	49	446	855	14
PDM630/T		235	6,5			750	450	750							

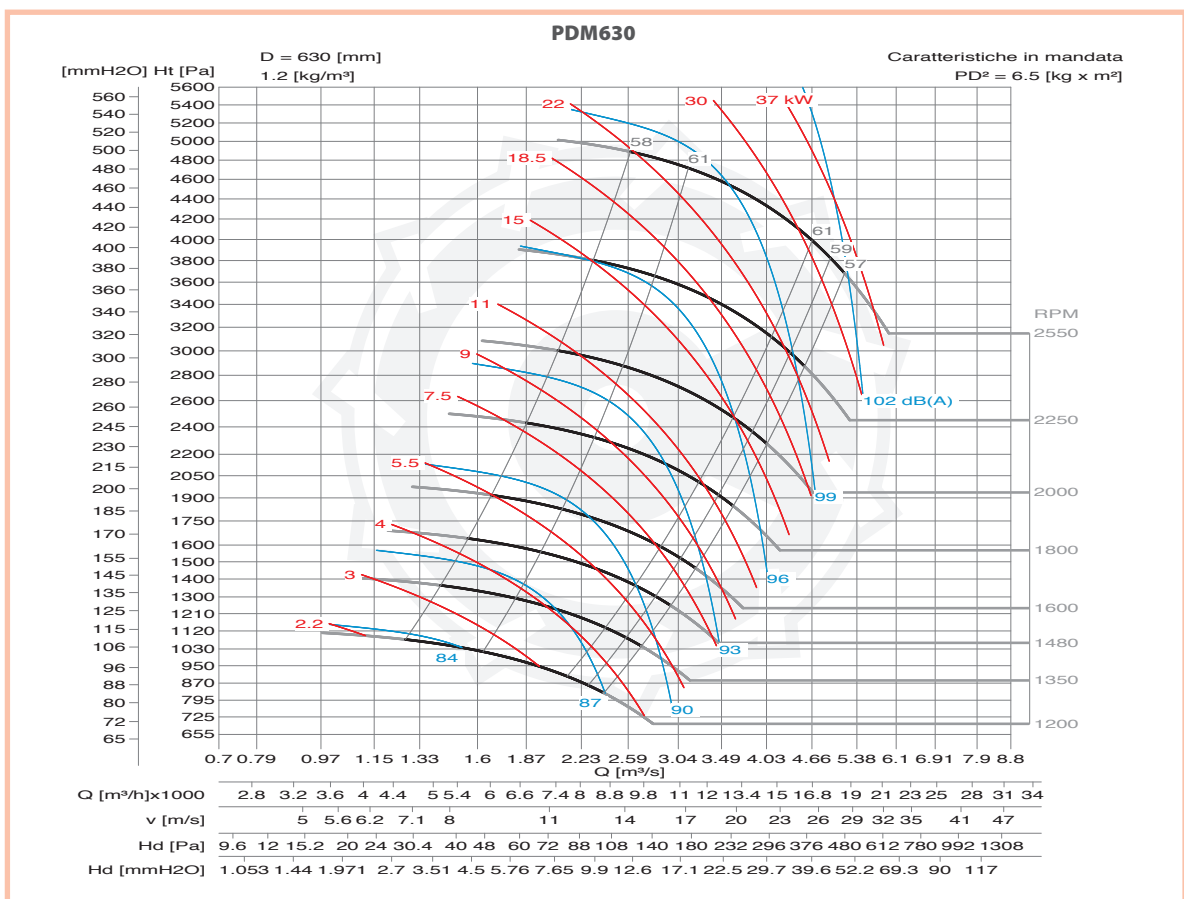
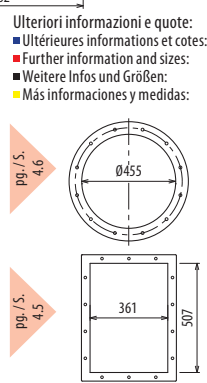

PDM

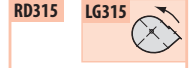
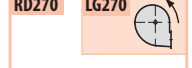
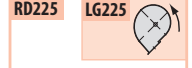
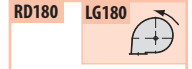
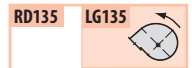
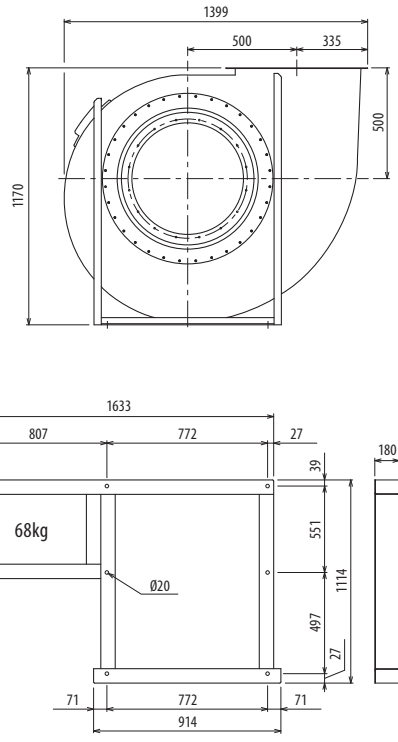
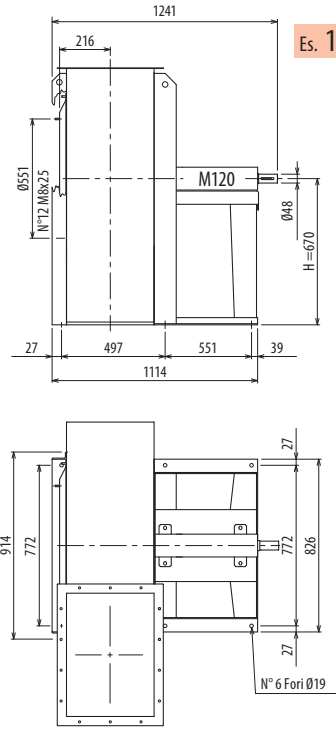
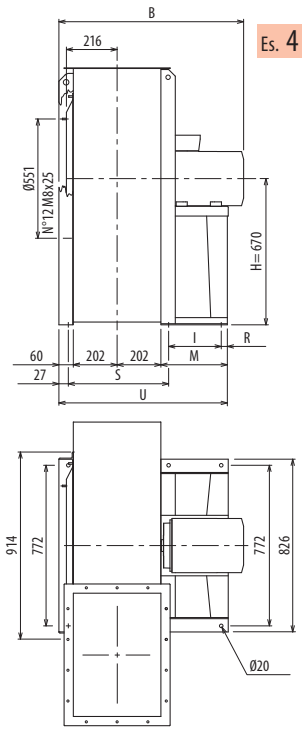

Il ventilatore non è orientabile • Peso in tabella comprensivo di motore

■ Le ventilateur n'est pas orientable
Le poids dans le tableau inclut le moteur

■ The fan is not revolvable
The weight indicated in the table includes motor

■ Der Ventilator ist nicht drehbar
Gewichtsangabe in Tabelle inkl. Motor

■ El ventilador no es orientable
El peso en la tabla incluye el motor

Ulteriori informazioni e quote:

■ Ulérieures informations et cotes:
Further information and sizes:
■ Weitere Infos und Größen:
■ Más informaciones y medidas:

TIPO - Type		PESO Weight	PD ²	B	I	H	H1	H2	R	S	M	U
VENTILATORE Fan	MOTORE Motor	Kg	Kgf x m ²									
PDM710/4R	160 M4	358	10	942	316	670	500	850	49	497	436	889
PDM710/4	160 L4	370	11	942	316	670	500	850	49	497	436	889
PDM710/T		350	11			670	500	850				

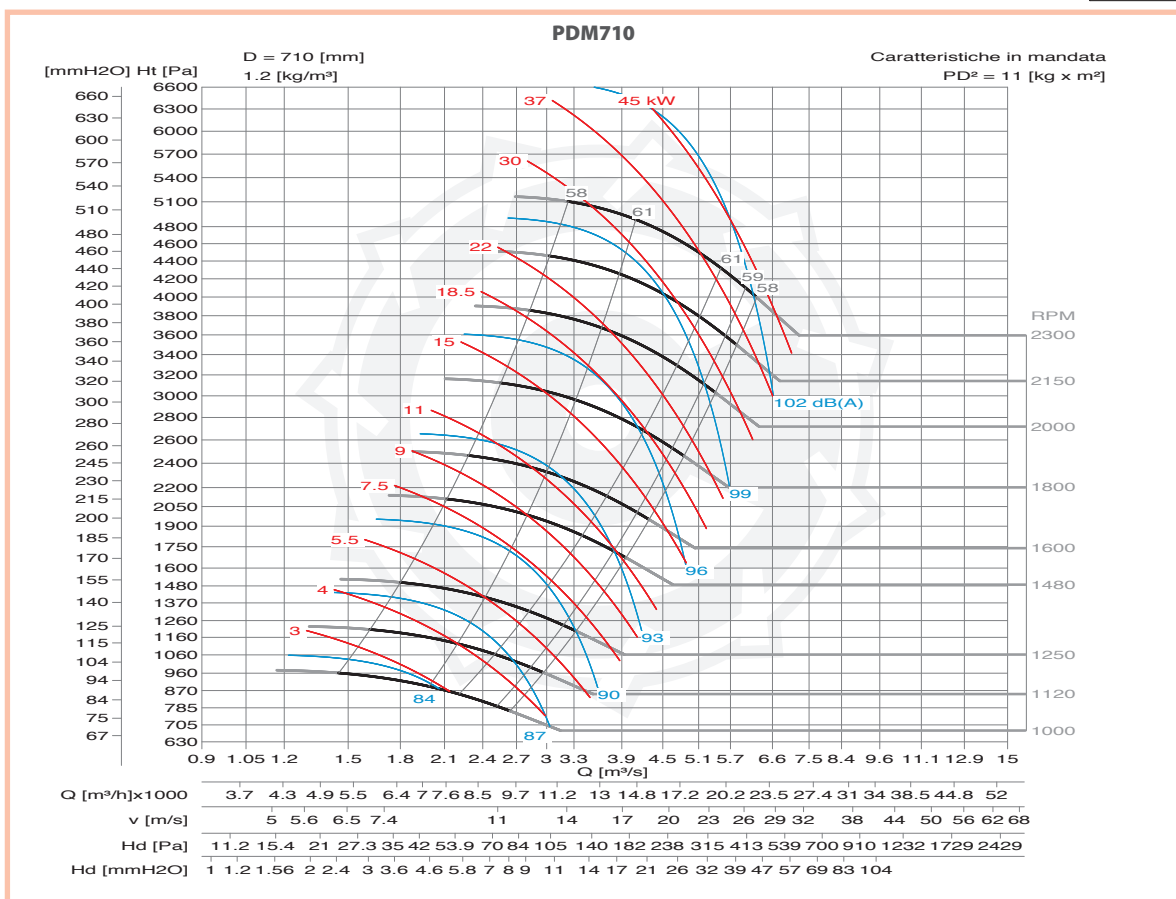
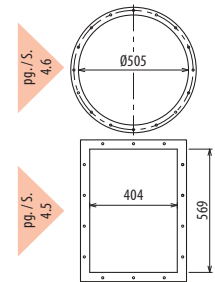

PDM

DIMENSIONI D'INGOMBRO E PESI/CURVE DI FUNZIONAMENTO

■ DIMENSIONS D'ENCOMBREMENT ET POIDS/COURBES DE FONCTIONNEMENT ■ OVERALL DIMENSIONS AND WEIGHT/WORKING CURVES
 ■ AUSMAßE UND GEWICHTE/FUNKTIONSKURVEN ■ DIMENSIONES QUE OCUPA Y PESOS/CURVAS DE FUNCIONAMIENTO

PDM800

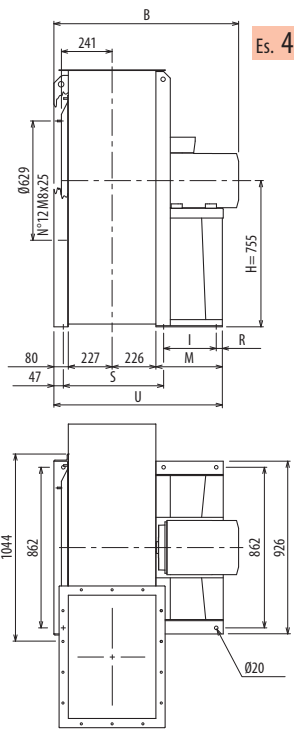

Es. 4

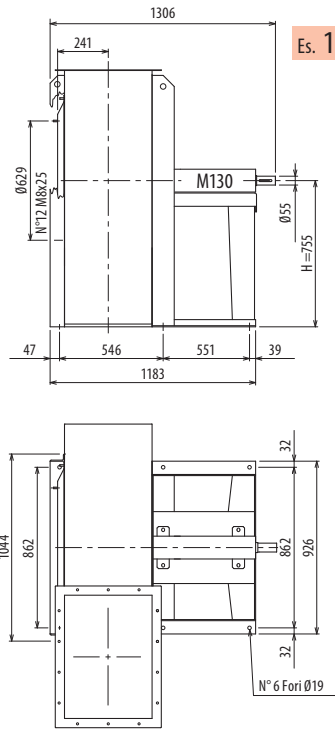

Es. 1

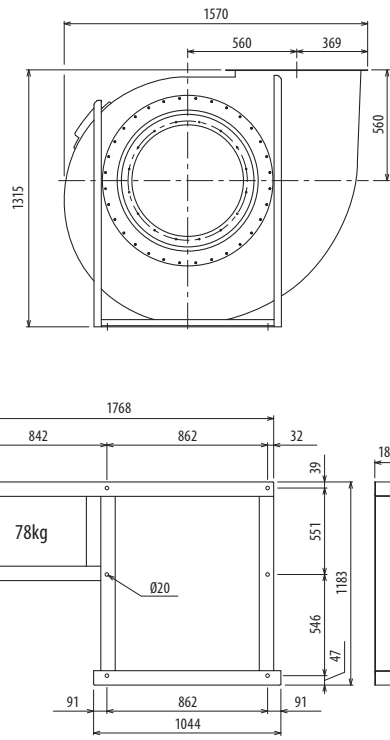

Il ventilatore non è orientabile • Peso in tabella comprensivo di motore

- Le ventilateur n'est pas orientable ■ The fan is not revolvable ■ Der Ventilator ist nicht drehbar ■ El ventilador no es orientable
- Le poids dans le tableau inclut le moteur ■ The weight indicated in the table includes motor ■ Gewichtsangabe in Tabelle inkl. Motor ■ El peso en la tabla incluye el motor

Ulteriori informazioni e quote:
 ■ Ulérieures informations et cotes:
 ■ Further information and sizes:
 ■ Weitere Infos und Größen:
 ■ Más informaciones y medidas:

TIPO - Type		PESO Weight	PD²											
VENTILATORE Fan	MOTORE Motor	Kg	Kgf x m²	B	I	H	H1	H2	R	S	M	U		
PDM800/4R	180 M4	526	17	1092	361	755	560	950	39	546	460	993		
PDM800/4	200 L4	639	19	1200	401	755	560	950	39	546	500	1033		
PDM800/T		420	19			755	560	950						

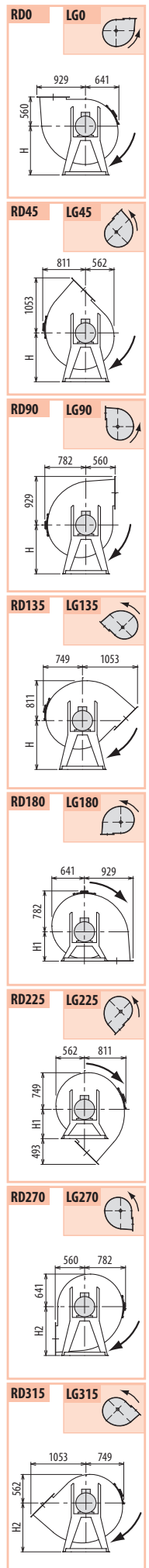
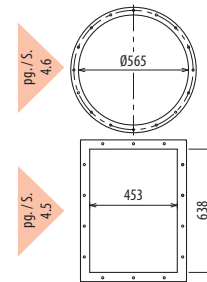

PDM

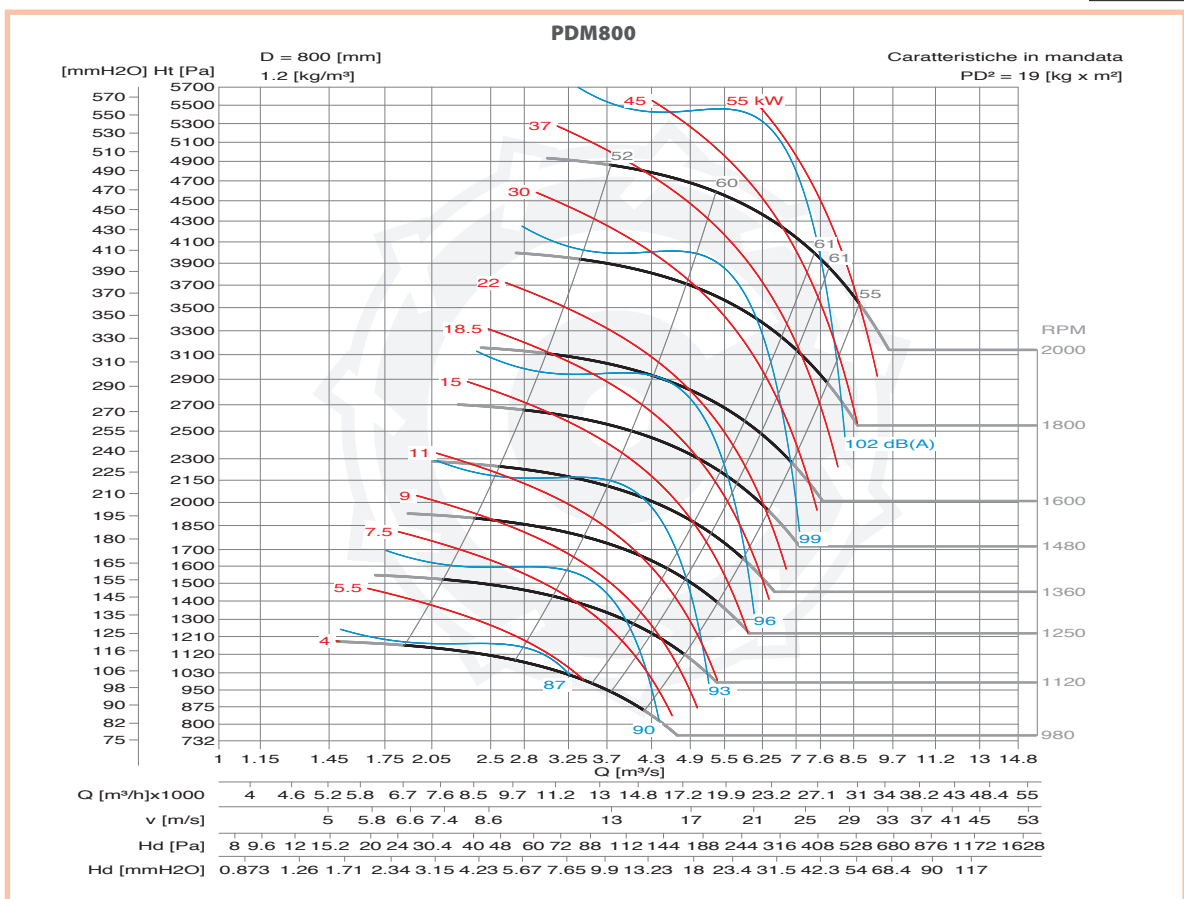

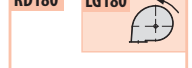
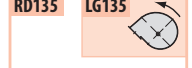
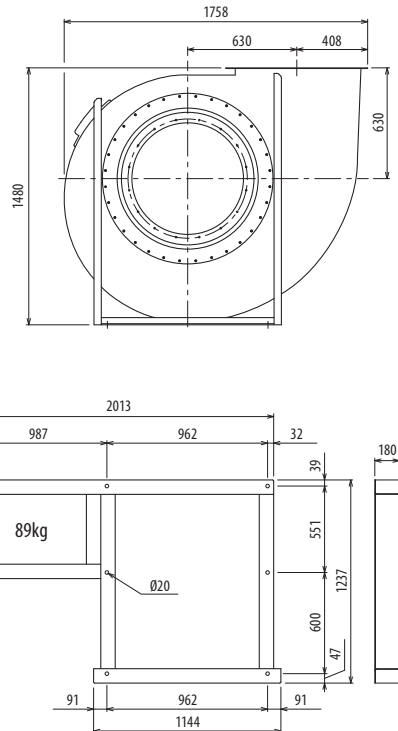
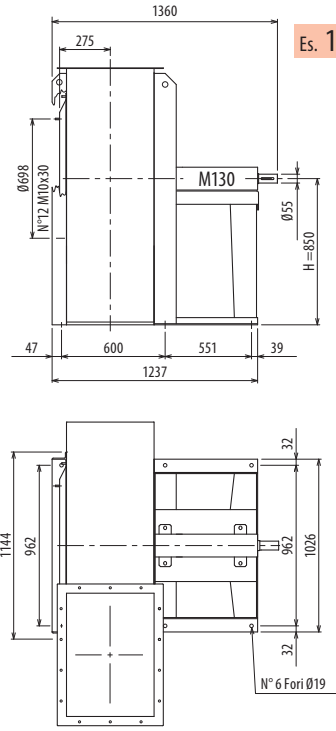
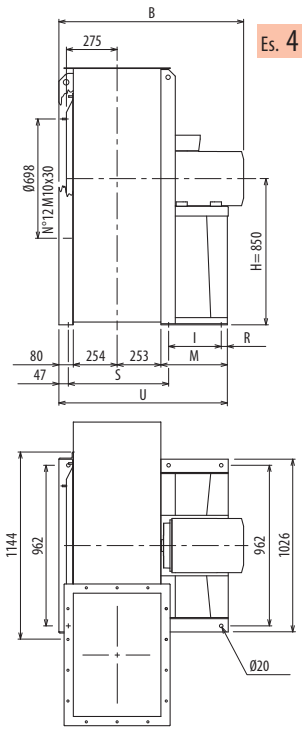

Il ventilatore non è orientabile • Peso in tabella comprensivo di motore

■ Le ventilateur n'est pas orientable
Le poids dans le tableau inclut le moteur

■ The fan is not revolvable
The weight indicated in the table includes motor

■ Der Ventilator ist nicht drehbar
Gewichtsangabe in Tabelle inkl. Motor

■ El ventilador no es orientable
El peso en la tabla incluye el motor

Ulteriori informazioni e quote:

- Ulérieures informations et cotes:
- Further information and sizes:
- Weitere Infos und Größen:
- Más informaciones y medidas:

TIPO - Type		PESO Weight Kg	PD ² Kg x m ²	B	I	H	H1	H2	R	S	M	U
VENTILATORE Fan	MOTORE Motor											
PDM900/4R	225 S4	782	32	1236	441	850	630	1060	39	600	540	1127
PDM900/4	225 M4	817	34	1296	441	850	630	1060	39	600	540	1127
PDM900/T		515	34			850	630	1060				

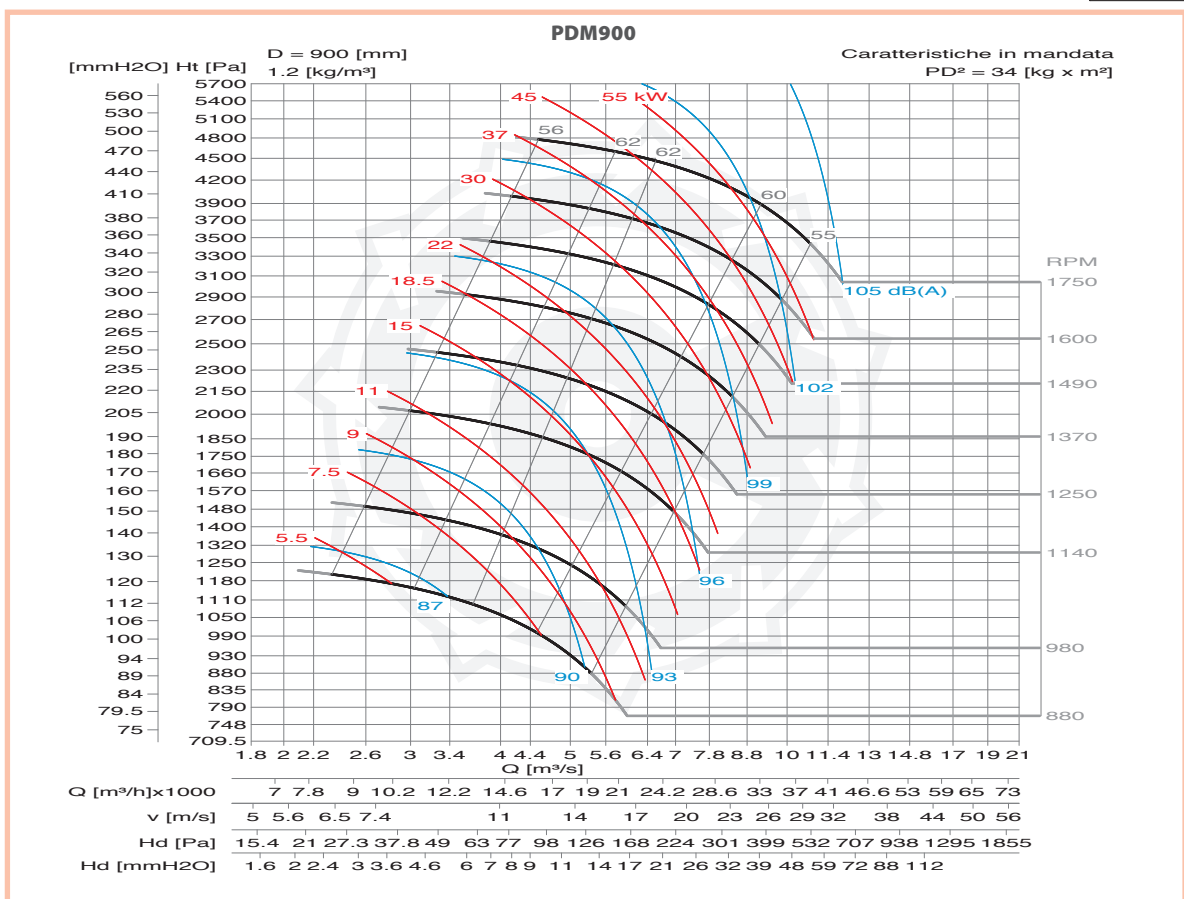
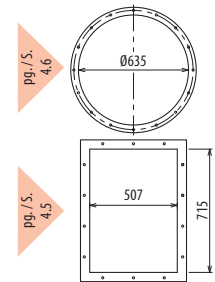

■ DIMENSIONS D'ENCOMBREMENT ET POIDS/COURBES DE FONCTIONNEMENT ■ OVERALL DIMENSIONS AND WEIGHT/WORKING CURVES
 ■ AUSMAßE UND GEWICHTE/FUNKTIONSKURVEN ■ DIMENSIONES QUE OCUPA Y PESOS/CURVAS DE FUNCIONAMIENTO

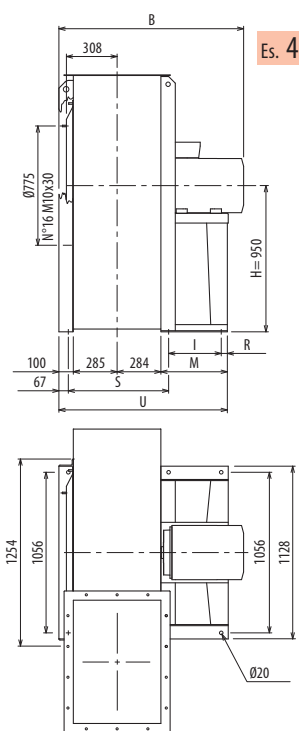

Es. 4

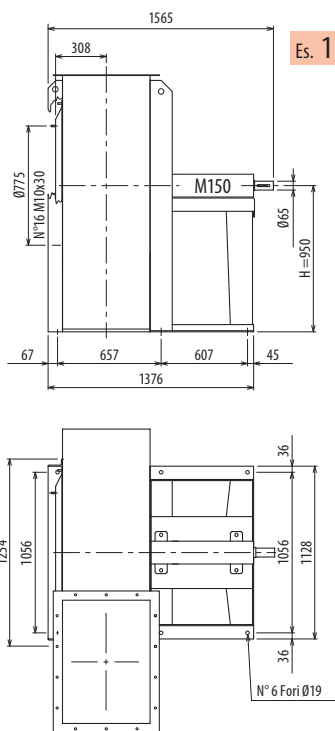

Es. 1

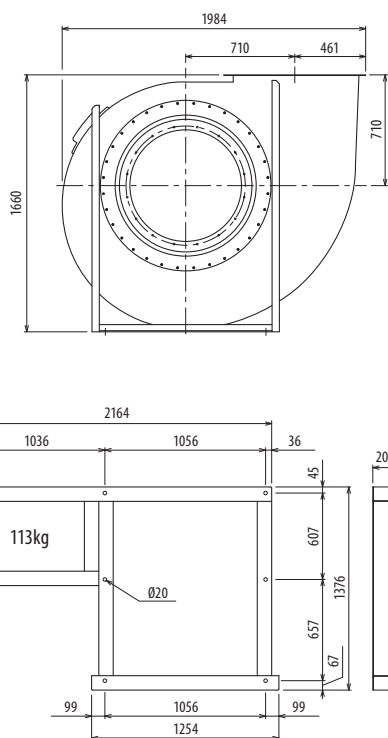

Il ventilatore non è orientabile • Peso in tabella comprensivo di motore

- Le ventilateur n'est pas orientable
- The fan is not revolvable
- Der Ventilator ist nicht drehbar
- El ventilador no es orientable
- Further information and sizes:
- Weitere Infos und Größen:
- Más informaciones y medidas:

Ulteriori informazioni e quote:
 ■ Further information and sizes:
 ■ Weitere Infos und Größen:
 ■ Más informaciones y medidas:

TIPO - Type		PESO Weight	PD ²									
VENTILATORE Fan	MOTORE Motor	Kg	Kgf x m ²	B	I	H	H1	H2	R	S	M	U
PDM1000/4R	250 M4	1083	48	1486	500	950	710	1180	45	657	600	1269
PDM1000/4	280 S4	1227	53	1489	590	950	710	1180	45	657	690	1359
PDM1000/T		732	53			950	710	1180				

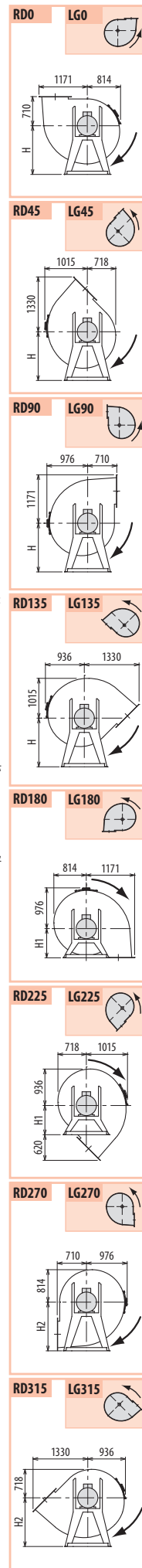
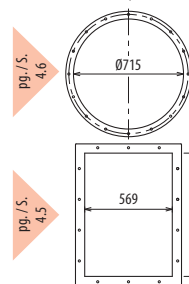

PDM

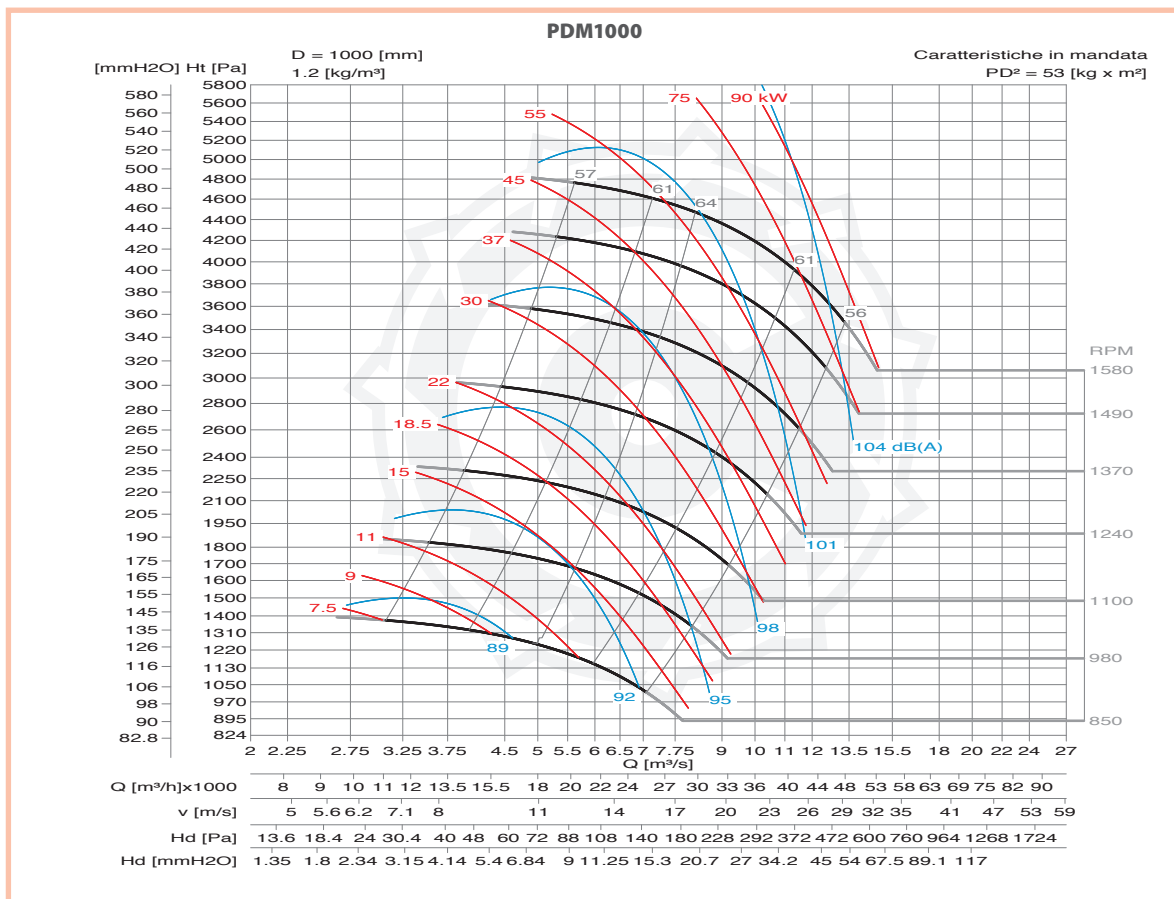

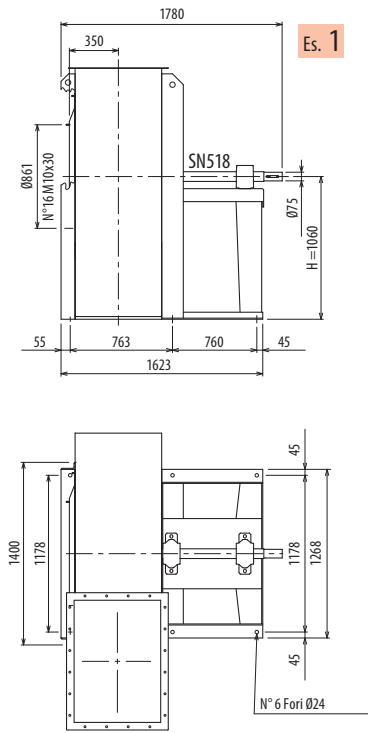

Es. 1

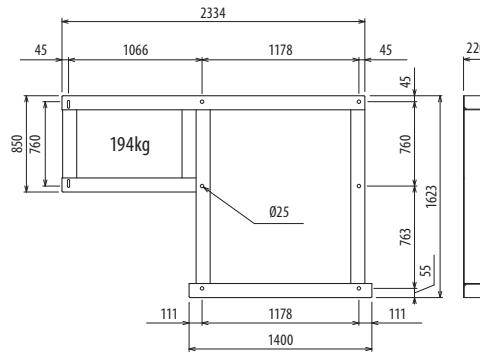
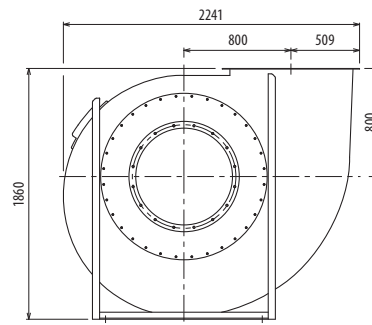

Il ventilatore non è orientabile

■ Le ventilateur n'est pas orientable

■ The fan is not revolvable

■ Der Ventilator ist nicht drehbar

■ El ventilador no es orientable

TIPO - Type		PESO Weight	PD ²											
VENTILATORE Fan	MOTORE Motor	Kg	Kgf x m ²	B	I	H	H1	H2	R	S	M	U		
PDM1120/T		1040	120			1060	800	1320						

Ulteriori informazioni e quote:

■ Ulérieures informations et cotes:

■ Further information and sizes:

■ Weitere Infos und Größen:

■ Más informaciones y medidas:

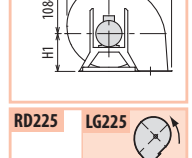
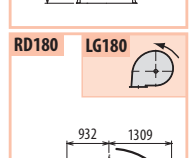
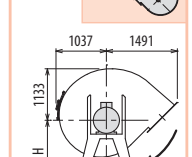
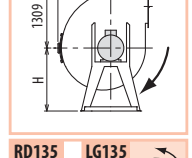
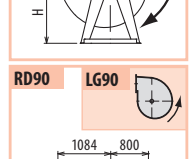
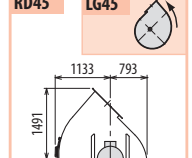
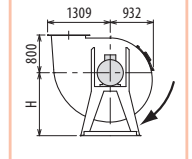
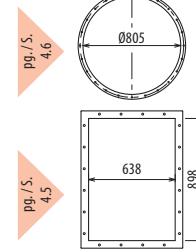

PDM1120

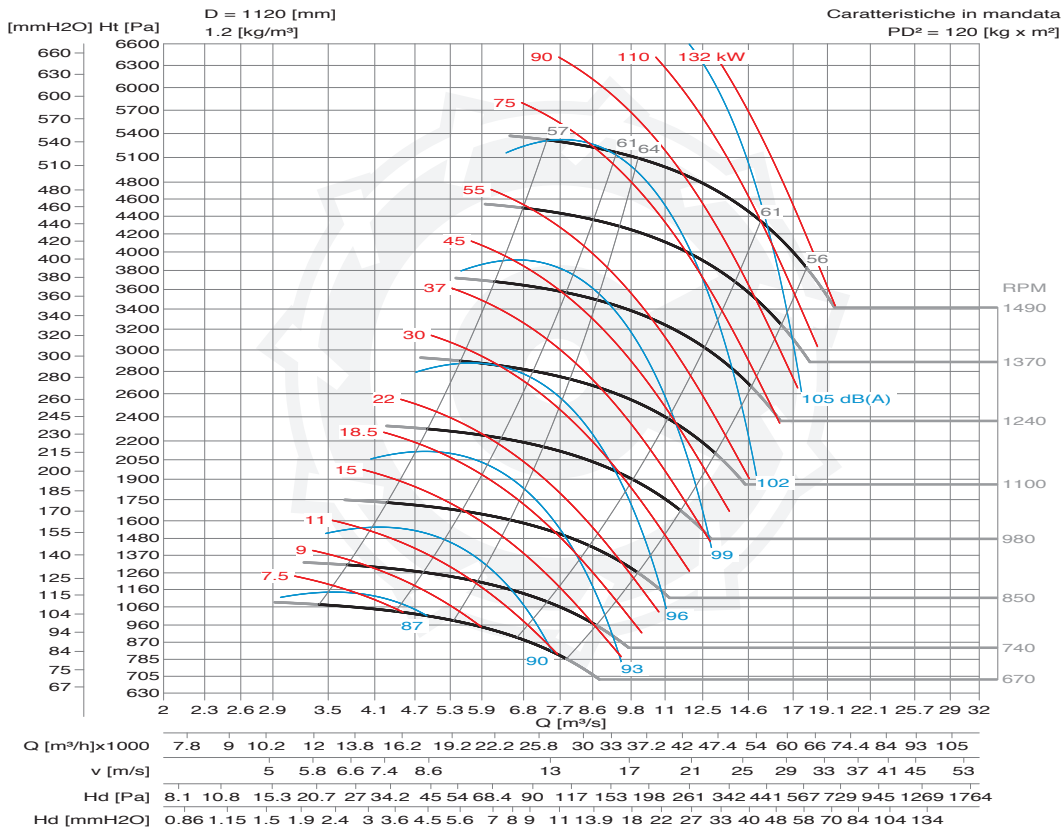

■ DIMENSIONS D'ENCOMBREMENT ET POIDS/COURBES DE FONCTIONNEMENT ■ OVERALL DIMENSIONS AND WEIGHT/WORKING CURVES
 ■ AUSMAßE UND GEWICHTE/FUNKTIONSKURVEN ■ DIMENSIONES QUE OCUPA Y PESOS/CURVAS DE FUNCIONAMIENTO

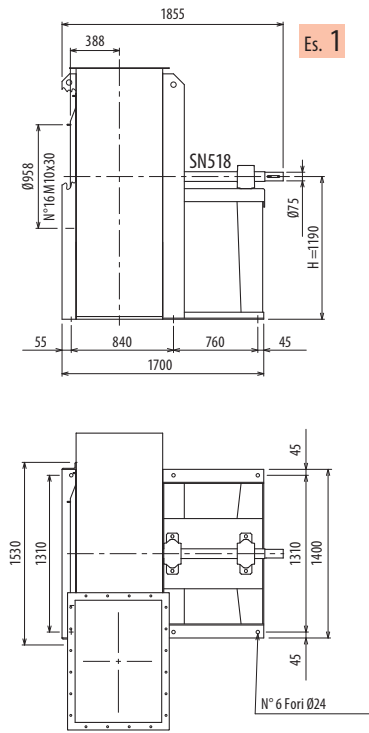

Es. 1

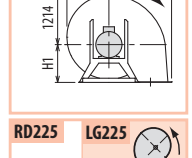
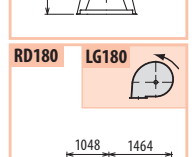
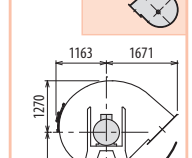
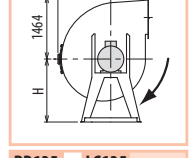
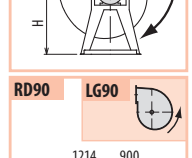
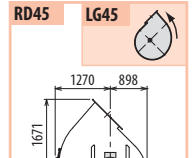
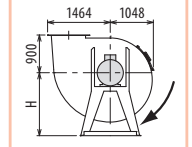
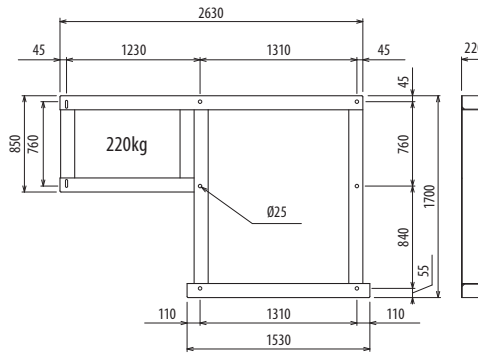
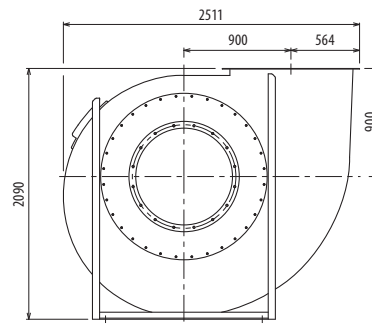

Il ventilatore non è orientabile

■ Le ventilateur n'est pas orientable ■ The fan is not revolvable ■ Der Ventilator ist nicht drehbar ■ El ventilador no es orientable

TIPO - Type		PESO Weight	PD ²	B	I	H	H1	H2	R	S	M	U
VENTILATORE Fan	MOTORE Motor	Kg	Kgf x m ²									
PDM1250/T		1195	190			1190	900	1500				

Ulteriori informazioni e quote:
 ■ Ulérieures informations et cotes:
 ■ Further information and sizes:
 ■ Weitere Infos und Größen:
 ■ Más informaciones y medidas:

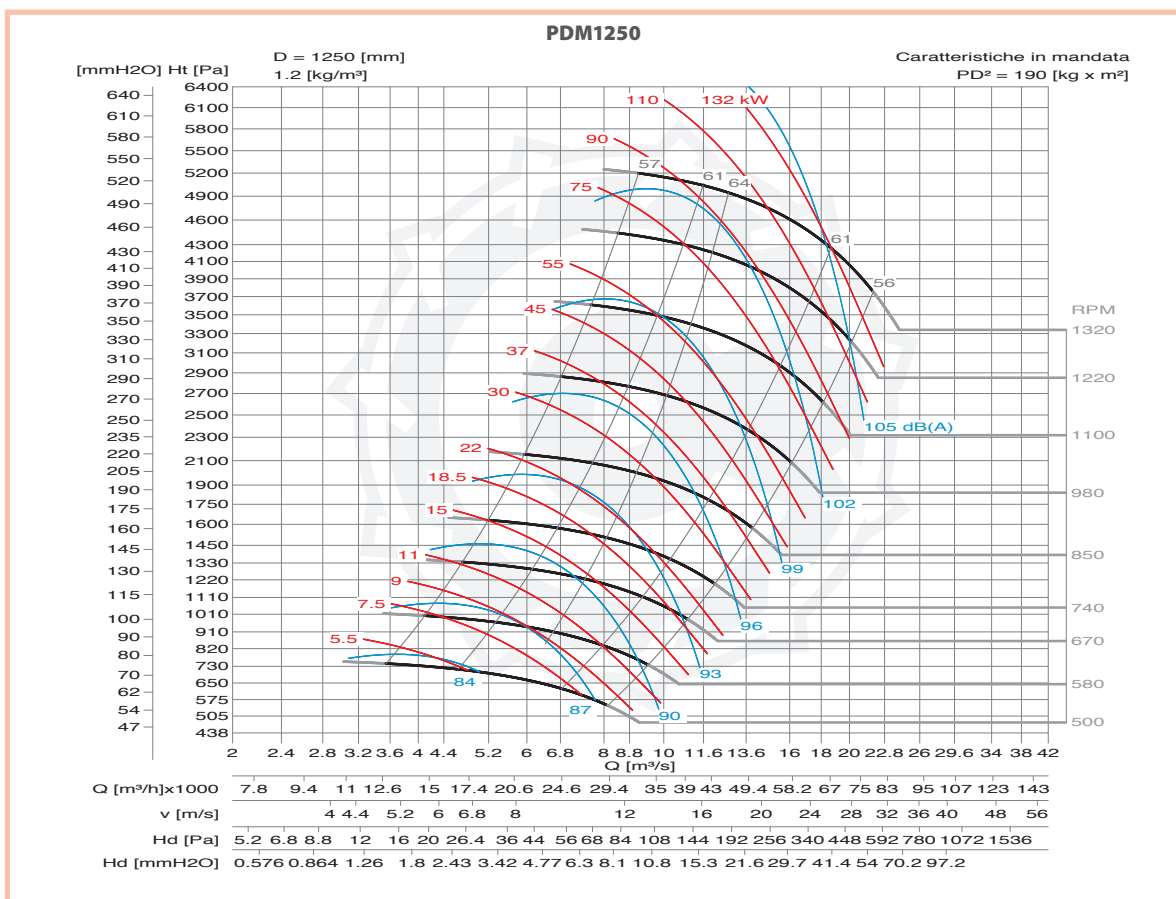
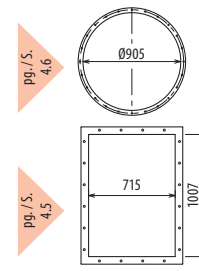

PDM



CORAL ENGINEERING SRL

Via Venezia 4/6 - 20060 Trezzano Rosa (MI) ITALY

• +39 02 95301003 - Fax +39 02 95301004

e-mail: info@coral.it <http://www.coral.it>

SOCIETÀ DI ENGINEERING - SOCIÉTÉS D'INGENIERIE - ENGINEERING SISTER COMPANIES - INGENIEURFIRMEN - SOCIEDADES DE INGENIERIA

ITALIA

MILANO • +39 02 95301003
TORINO • +39 011 9980141
VICENZA • +39 0444 348999

FRANCE

LYON • +33 4 74 944 562
PARIS • +33 1 60 868 069
POITIERS • +33 5 49 379 596

ENGLAND

LITTLEBOROUGH ROCHDALE • +44 1 706 373100